

**EURAMET comparison 1244
Comparison of aerosol electrometers**

**Issue 2 :
EURAMET REPORT**

**Paul Quincey
Dimitris Sarantaridis
Jaakko Yli-Ojanperä
Jorma Keskinen
Richard Högström
Martti Heinonen
Felix Lüönd
Andreas Nowak
Francesco Riccobono
Thomas Tuch
Hiromu Sakurai
Miles Owen**

NOT RESTRICTED

JUNE 2014

EURAMET 1244: Comparison of aerosol electrometers

Paul Quincey¹, Dimitris Sarantaridis¹, Jaakko Yli-Ojanperä², Jorma Keskinen², Richard Högström³, Martti Heinonen³, Felix Lüönd⁴, Andreas Nowak⁵, Francesco Riccobono⁶, Thomas Tuch⁷, Hiromu Sakurai⁸, and Miles Owen⁹

¹ Analytical Science Division, National Physical Laboratory, Hampton Road, Teddington, TW11 0LW, UK.

² Tampere University of Technology (TUT), Department of Physics, Aerosol Physics Laboratory, Korkeakoulunkatu 3, FI-33101 Tampere, Finland

³ MIKES – Centre for Metrology and Accreditation, Tekniikantie 1, FI-02151 Espoo, Finland

⁴ Federal Institute of Metrology (METAS), Lindenweg 50, CH-3003 Bern-Wabern, Switzerland

⁵ Physikalisch-Technische Bundesanstalt (PTB), Bundesallee 100, D-38116 Braunschweig, Germany

⁶ European Commission, Joint Research Centre (JRC), Via E. Fermi 2749, I-21027 Ispra (VA), Italy

⁷ Leibniz Institute für Troposphärenforschung (TROPOS), Permoserstraße 15, D-04318 Leipzig, Germany

⁸ National Metrology Institute of Japan, National Institute of Advanced Industrial Science and Technology (AIST), 1-1-1 Umezono, Tsukuba, Ibaraki, Japan

⁹ US Army Primary Standards Laboratory (APSL), Bldg 5435 Fowler Rd, Redstone Arsenal, AL 35898, United States

© Queen's Printer and Controller of HMSO 2014

ISSN 1754-2928

Issue 1 published January 2014

Issue 2 published June 2014

National Physical Laboratory
Hampton Road, Teddington, Middlesex, TW11 0LW

Extracts from this report may be reproduced provided the source is acknowledged
and the extract is not taken out of context.

Approved on behalf of NPLML by
Dr Michael Adeogun, Head of Analytical Science Division.

EURAMET 1244: Comparison of aerosol electrometers

EXECUTIVE SUMMARY

Aerosol particle number concentration has recently featured in vehicle emission legislation and is becoming increasingly important in other areas such as ambient air monitoring. Number concentration measurements are also often integral to particle size distribution measurements, such as when using a Mobility Particle Size Spectrometer.

The draft ISO standard ISO/DIS 27891 [1] describes a calibration procedure for Condensation Particle Counters (CPCs - the usual type of instrument for measuring particle number concentration in the size range from a few nanometers to a few micrometers) by reference to an aerosol electrometer. If a source of singly-charged particles is used, number concentration (typically in units of cm^{-3}) is directly comparable to charge concentration (eg in $\text{fC}\cdot\text{cm}^{-3}$). The DIS refers to the role of NMIs in providing certification for both reference aerosol electrometers and reference CPCs.

The aim of this comparison was to compare the results of different laboratories' measurements of charge concentration – in practice the combination of electrometer current (eg in fA), air flow (eg in $\text{cm}^3\cdot\text{s}^{-1}$) and any losses of particles within the instrument.

The comparison took place at the Tampere University of Technology in Finland in March 2013 as part of the EMRP project ENV02 PartEmission (Automotive combustion particle metrics), Deliverable 1.2.2.

Because this is the first multi-NMI comparison of aerosol electrometers, EURAMET participants were joined by other participants with strong metrological expertise in this area.

The comparison included aerosol charge concentrations between about 0.15 and 3 $\text{fC}\cdot\text{cm}^{-3}$, and aerosol particle sizes from 6 to 200 nm, using aerosol particles composed of di-octyl sebacate, NaCl and soot. The results suggest that, away from low charge concentration and low particle size, agreement to $\pm 3\%$ between reference laboratories using different designs of instrument is already typical, and that uncertainties of less than $\pm 1\%$ (2σ) are achievable.

TABLE OF CONTENTS**EXECUTIVE SUMMARY****TABLE OF CONTENTS**

1. INTRODUCTION	8
2. OPERATION OF THE COMPARISON	8
2.1. PARTICIPANTS	8
2.2. PROCEDURE	8
2.3. MODIFICATIONS TO THE PROCEDURE	10
2.4. COMPARISON RUNS	10
2.5. REPORTING OF RESULTS	11
3. RESULTS	11
3.1. REPORTED RESULTS	11
3.2. PRELIMINARY ASSESSMENT	11
3.3. COMPARISON REFERENCE VALUE	12
3.4. GRAPHICAL PRESENTATION OF RESULTS	12
4. DISCUSSION AND CONCLUSIONS	15
4.1. SUMMARY OF RESULTS	15
4.2. SUPPORTED CMC CLAIMS	15
5. REFERENCES	15
APPENDICES	17
APPENDIX A1 – EURAMET 1244 PROTOCOL	17
APPENDIX A2 – PARTICIPANTS RESULTS PROFORMAS	21

1. INTRODUCTION

Aerosol particle number concentration has recently featured in vehicle emission legislation and is becoming increasingly important in other areas such as ambient air monitoring. Number concentration measurements are also often integral to particle size distribution measurements, such as when using a Mobility Particle Size Spectrometer.

The draft ISO standard ISO/DIS 27891 [1] describes a calibration procedure for Condensation Particle Counters (CPCs - the usual type of instrument for measuring particle number concentration in the size range from a few nanometers to a few micrometers) by reference to an aerosol electrometer. If a source of singly-charged particles is used, number concentration (typically in units of cm^{-3}) is directly comparable to charge concentration (eg in $\text{fC}\cdot\text{cm}^{-3}$). A charge concentration of $1 \text{ fC}\cdot\text{cm}^{-3}$ corresponds to 6241 elementary charges cm^{-3} . The CD refers to the role of NMIs in providing certification for reference aerosol electrometers and reference CPCs.

Although not strictly a chemical measurement, the comparison belongs in the Gas subcommittee of TC-MC because of the similarity to gas concentration measurements, following the precedent of earlier projects 893 (workshops to establish “Metrology infrastructure for airborne nanoparticles”) and 1027 (“Comparison of combustion particle number concentration and size”).

The aim of this comparison was to compare the results of different laboratories’ measurements of charge concentration – in practice the combination of electrometer current (eg in fA), air flow (eg in $\text{cm}^3\cdot\text{s}^{-1}$) and any losses of particles within the instrument.

The comparison took place in Finland in March 2013 as part of the EMRP project ENV02 PartEmission (Automotive combustion particle metrics), Deliverable 1.2.2.

Because this is the first multi-NMI comparison of aerosol electrometers, EURAMET participants were joined by other participants with strong metrological expertise in this area.

2. OPERATION OF THE COMPARISON

2.1. PARTICIPANTS

The 8 participating laboratories were:

- NPL – United Kingdom (co-ordinating laboratory)
- MIKES – Finland, in collaboration with Tampere University of Technology, the hosts
- METAS – Switzerland
- PTB – Germany
- JRC – EU
- TROPOS (Leipzig Institute for Tropospheric Research) - Germany
- AIST – Japan
- APSL (US Army Primary Standards Laboratory) – USA

2.2. PROCEDURE

The comparison was held at the Tampere University of Technology (TUT) in Finland during the week 18-22 March 2013.

Because transportable measurement standards for aerosols are not easily available, participants brought their aerosol electrometers and any associated equipment to TUT. The aerosol electrometers were connected to a common aerosol source using pipework designed to minimise differences between the 8 ports, for example due to diffusive losses of particles to the pipework walls.

Two types of airborne particle generator were used for the comparison. Most were from the TUT-developed Single Charged Aerosol Reference (SCAR) generator (approximately 12 nm-sized NaCl particles, singly-charged then grown with di-octyl sebacate (DOS) to be larger, singly-charged particles) [2,3]. At the smallest sizes, no growth is involved, and the particles are simply NaCl.

Two additional runs were made using particles from a soot generator. This arrangement would contain a proportion of multiply-charged particles and would more closely resemble the equipment likely to be used in most laboratories, at least in the short term.

The layout is shown schematically in Figure 1.

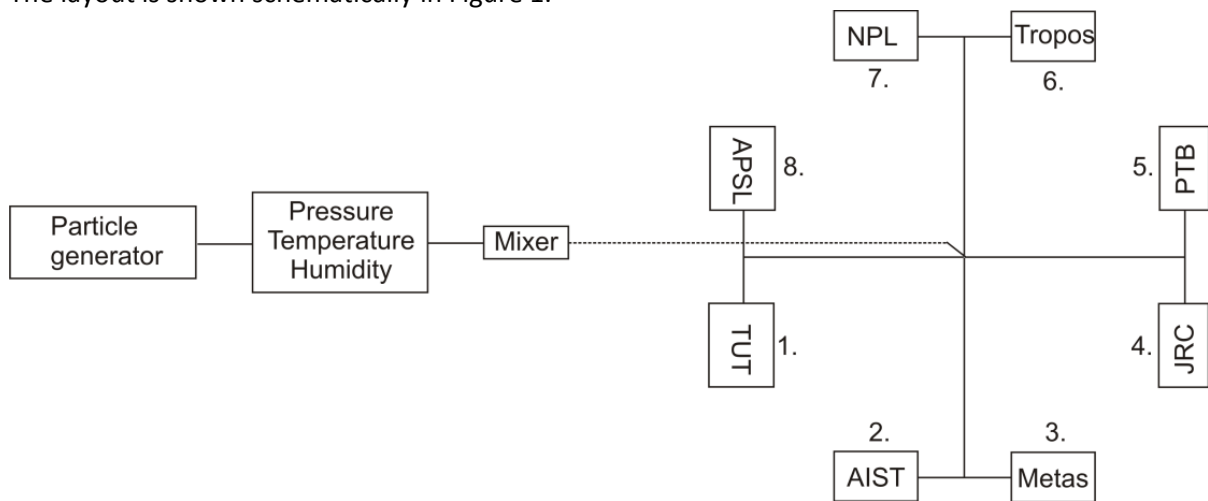

Figure 1: schematic laboratory layout

All equipment was operated by people from the relevant participant laboratories, with the exception of the APSL equipment, which was operated on their behalf by NPL.

Several different designs of aerosol electrometer were used. The majority of participants used the model TSI 3068B, NPL used a GRIMM 5.705, JRC used an Ionel EL-5030, and MIKES-TUT used a self-designed and constructed instrument.

Particle sizes were selected within the nominal range 6 to 200 nm, and the concentration range was between around 0.16 to 2.9 fC.cm⁻³, equivalent to around 1 000 to 18 000 singly-charged particles cm⁻³.

Aerosol particle size was characterised by a Mobility Particle Size Spectrometer (MPSS). Accurate assignment of size to aerosol particle distributions is a complex topic in itself, and was not a central aspect of the comparison. The comparison was primarily concerned with the ability of the participants to measure the charge concentration of the aerosol, while the different sizes were used to indicate limitations of the aerosol electrometers and the experimental design – for example at low particle size where higher diffusive losses would be expected.

Further details of the procedure followed are given in the Protocol (Appendix 1), and of the equipment and methods used by the participants in the Results Proformas (Appendix 2).

2.3. MODIFICATIONS TO THE PROCEDURE

During the comparison, unexplained spikes were observed in some of the electrometer signals, to a greater extent than was expected. The effect was not observed equally by all participants, and affected PTB the most. Participants were allowed to remove the effect of these from their reported results, and the Results Proforma was modified accordingly.

2.4. COMPARISON RUNS

There were 22 designated runs, the first of which was at zero concentration. Run 17 was abandoned for technical reasons and not reported. The runs are described in the Table below.

Experiment	Nominal particle size (nm)	Nominal concentration cm-3	Particle material	Measured mode size (nm)	Estimated uncertainty of mode size (k=2) (nm)	Geometric standard deviation of the size distribution	Fraction of multiply-charged particles (%)
run 1	N/A	0	N/A	N/A	N/A	N/A	N/A
run 2	100	18000	DOS	106	3.9	1.10	0
run 3	100	10000	DOS	102	3.7	1.10	0
run 4	100	8000	DOS	102	3.7	1.10	0
run 5	100	6000	DOS	98	3.6	1.10	0
run 6	100	4000	DOS	100	3.6	1.10	0
run 7	100	2000	DOS	102	3.7	1.10	0
run 8	100	1000	DOS	102	3.7	1.10	0
run 9	12	10000	NaCl	12	0.7	1.02	0
run 10	20	10000	DOS	21	5.8	1.13	0
run 11	30	10000	DOS	31	1.1	1.10	0
run 12	50	10000	DOS	50	6.0	1.07	0
run 13	75	10000	DOS	82	2.9	1.07	0
run 14	100	10000	DOS	98	3.6	1.10	0
run 15	100	2000	DOS	102	4.7	1.13	0
run 16	100	1000	DOS	106	3.9	1.11	0
run 18	200	12000	DOS	202	8.3	1.10	0
run 19	6	4000	NaCl	6	0.2	1.02	0
run 20	8	7500	NaCl	8	0.3	1.02	0
run 21	20	2500	Soot	20	0.8	1.65	1.21
run 22	30	4000	Soot	30	0.8	1.65	2.93

Table 1: Description of each run.

In summary:

Runs 2-20 had narrow size distributions with geometric standard deviation (σ_g) below 1.2.

Runs 2-8 and 14-16 all used 100 nm sized DOS particles, at nominal concentrations between 1,000 and 18,000 cm⁻³, three of which were repeated on separate days.

Run 18 used larger DOS particles of nominal size 200 nm, at a nominal concentration of 12,000 cm⁻³.

Runs 10-13 used smaller DOS particles of nominal sizes between 20 and 75 nm, at a nominal concentration of 10,000 cm⁻³.

Runs 9, 19 and 20 used NaCl particles of nominal sizes between 6 and 12 nm, at nominal concentrations between 4,000 and 10,000 cm⁻³.

Runs 21 and 22 used broader size distributions ($\sigma_g > 1.2$) of soot particles, centred on 20 and 30 nm respectively.

2.5. REPORTING OF RESULTS

As described in the Protocol (Appendix 1), provisional results were exchanged and viewed during the comparison, to clarify any practical issues arising from this first comparison of its kind, and to facilitate the preparation of a research paper, now accepted by Metrologia. Final results were sent subsequently via email using the agreed Proformas (Appendix 2), to allow for recalibration of equipment after its return to the home laboratory. Any changes from the provisional data are explained in the Proformas.

Participants estimated their own measurement uncertainties independently, with rationales explained on the Proformas.

3. RESULTS

3.1. REPORTED RESULTS

The full set of reported results (charge concentration and associated uncertainty $k=2$) of all laboratories (NPL, JRC, MIKES-TUT, APSL, METAS, TROPOS, PTB and AIST) for the comparison is given in Table 2.

Run	NPL		JRC		MIKES-TUT		APSL		METAS		TROPOS		PTB		AIST	
	fC.cm-3	u/c (k=2)	fC.cm-3	u/c (k=2)	fC.cm-3	u/c (k=2)	fC.cm-3	u/c (k=2)	fC.cm-3	u/c (k=2)	fC.cm-3	u/c (k=2)	fC.cm-3	u/c (k=2)	fC.cm-3	u/c (k=2)
1	0	0.0005	-0.0017	0.0002	0.0028	0.0153	0.001	0.025	-0.0032	0.0038	0.002	0.036	0.0019		0.009	0.006
2	2.77	0.031	2.0891	0.0382	2.7242	0.0314	2.766	0.082	2.718	0.02	2.696	0.054	2.6895	0.0420	2.779	0.036
3	1.514	0.017	1.1518	0.0211	1.5027	0.0188	1.529	0.051	1.502	0.012	1.497	0.048	1.4740	0.0420	1.531	0.022
4	1.213	0.013	0.9164	0.0167	1.2045	0.0153	1.223	0.043	1.205	0.008	1.191	0.048	1.1701	0.0420	1.226	0.016
5	1.182	0.013	0.8973	0.0164	1.1754	0.0149	1.191	0.045	1.174	0.012	1.177	0.048	1.1409	0.0420	1.188	0.017
6	0.591	0.009	0.4446	0.0081	0.5863	0.011	0.6	0.042	0.5858	0.007	0.578	0.048	0.5394	0.0420	0.599	0.017
7	0.3	0.004	0.2257	0.0041	0.2996	0.0082	0.298	0.037	0.2969	0.004	0.293	0.042	0.2439	0.0420	0.309	0.014
8	0.137	0.002	0.0998	0.0018	0.1363	0.0057	0.145	0.03	0.1364	0.0038	0.131	0.042	0.0829	0.0420	0.146	0.009
9	1.168	0.012	1.1027	0.0202	1.1604	0.0147	1.209	0.054	1.182	0.008	1.146	0.048	1.1605	0.0420	1.211	0.015
10	1.46	0.022	1.3182	0.0241	1.4553	0.0246	1.491	0.065	1.462	0.02	1.439	0.048	1.4349	0.0420	1.484	0.030
11	1.522	0.017	1.348	0.0246	1.5202	0.0204	1.561	0.048	1.531	0.012	1.506	0.048	1.4932	0.0420	1.557	0.023
12	1.605	0.018	1.3127	0.024	1.6065	0.0209	1.639	0.055	1.616	0.016	1.587	0.048	1.5683	0.0420	1.629	0.024
13	1.567	0.014	1.2217	0.0223	1.566	0.0176	1.602	0.051	1.573	0.008	1.551	0.048	1.5398	0.0420	1.591	0.021
14	1.592	0.017	1.2083	0.0221	1.597	0.0209	1.62	0.067	1.599	0.014	1.576	0.048	1.5512	0.0420	1.618	0.023
15	0.287	0.004	0.2183	0.004	0.289	0.0092	0.297	0.036	0.2903	0.0046	0.288	0.042	0.2604	0.0420	0.301	0.011
16	0.179	0.004	0.1309	0.0024	0.1807	0.0065	0.184	0.035	0.1804	0.0038	0.176	0.042	0.1483	0.0420	0.187	0.007
18	1.785	0.024	1.2816	0.0234	1.7784	0.0239	1.81	0.05	1.783	0.016	1.767	0.054	1.7491	0.0420	1.804	0.024
19	0.379	0.004	0.3455	0.0063	0.3894	0.012	0.395	0.04	0.3911	0.0038	0.372	0.042	0.3706	0.0420	0.405	0.007
20	0.86	0.009	0.7982	0.0146	0.8599	0.0148	0.895	0.038	0.879	0.0072	0.842	0.048	0.8474	0.0420	0.915	0.016
21	0.332	0.006	0.3037	0.0056	0.3254	0.0088	0.336	0.032	0.333	0.0068	0.316	0.042	0.3059	0.0420	0.338	0.009
22	0.625	0.012	0.547	0.01	0.6179	0.0152	0.634	0.038	0.6277	0.012	0.594	0.048	0.5942	0.0420	0.634	0.018

Table 2: Reported results

3.2. PRELIMINARY ASSESSMENT

A preliminary assessment of the results showed that while there was generally good agreement at around the 2% level, the JRC results were 10% to 30% lower than the other participants' results. The deviation was size dependent, with a larger deviation for larger particle sizes. The probable cause of this was thought to be the internal design of the aerosol electrometer used, a commercial design that has apparently been discontinued, leading to significant size-dependent internal losses.

The JRC results are therefore not considered further. They are not shown in the charts below, and were not taken into account when calculating the comparison reference value.

In addition, the PTB results were anomalously low for the low concentration runs, numbers 6, 7, 8, 15 and 16, albeit with large stated uncertainties. All PTB results are presented, but their results are not taken into account when calculating the comparison reference value for these specific runs.

3.3. COMPARISON REFERENCE VALUE

In the absence of an independent reference value, and bearing in mind of the provisional nature of the uncertainties assigned to the results, the comparison reference value is taken simply to be the mean of the reported results, with the exception of the cases mentioned in Section 3.2 (relating to JRC and PTB results).

3.4. GRAPHICAL PRESENTATION OF RESULTS

The results reported in Table 2 are also presented graphically in 5 Figures:

Figure 2: 100 nm DOS at a range of higher concentrations (Runs 2, 3, 4, 5, 14)

Figure 3: 100 nm DOS at a range of lower concentrations (Runs 6, 7, 8, 15, 16)

Figure 4: DOS at similar concentrations, with sizes from 20 to 200 nm (Runs 10, 11, 12, 13, 14, 18)

Figure 5: 20 and 30 nm soot particles at concentrations of about 2,500 and 4,000 cm⁻³ respectively (Runs 21 and 22)

Figure 6: NaCl particles at sizes 12, 8 and 6 nm, at concentrations of about 10,000, 7,500 and 4,000 cm⁻³ respectively (Runs 9, 19, 20)

Note that Run 14 appears in both Figure 2 and Figure 4.

In all cases the y-axis shows percentage difference from the comparison reference value, and the error bars are the k=2 uncertainties provided by the participants.

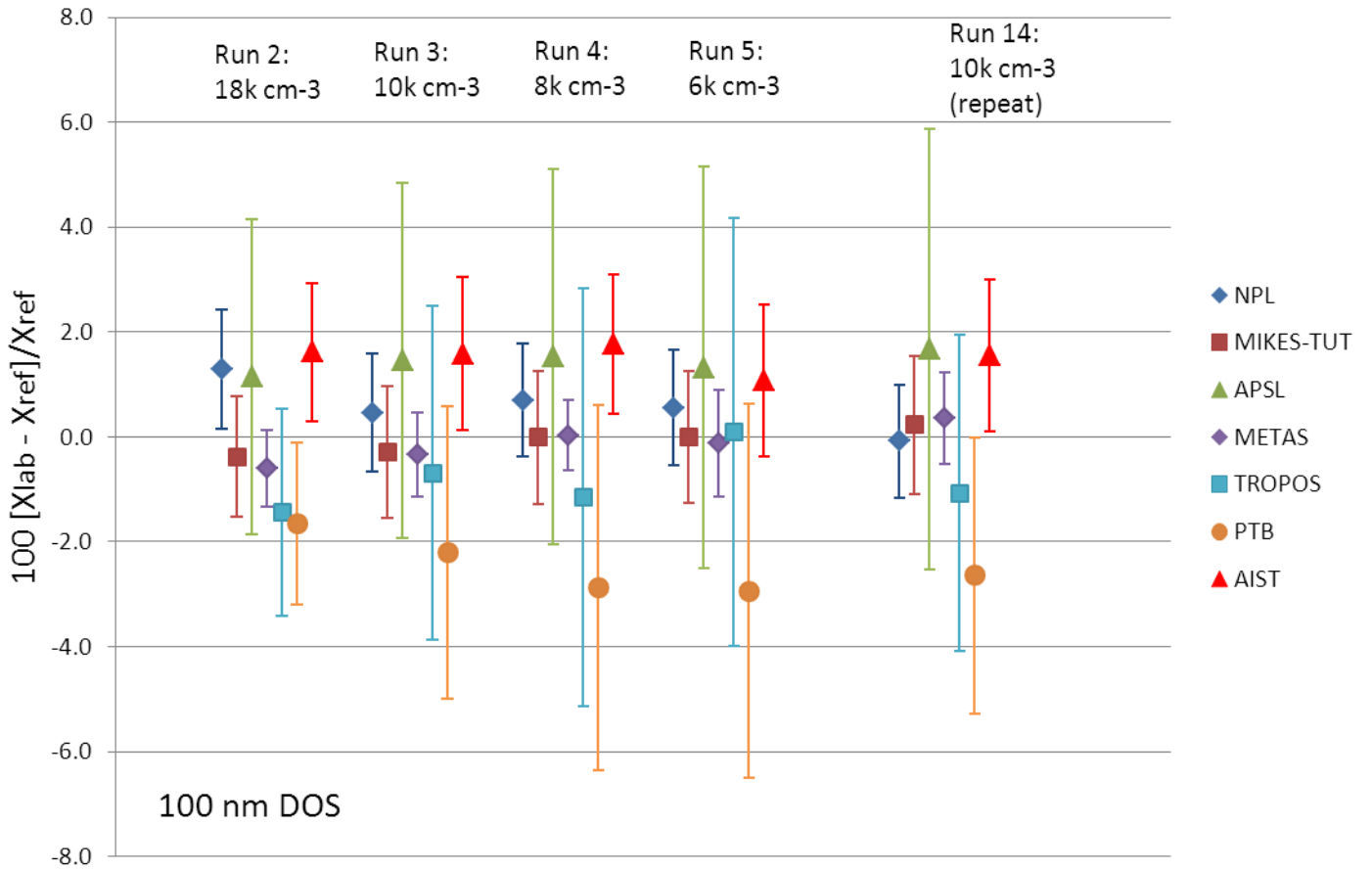

Figure 2. 100 nm DOS at a range of higher concentrations (Runs 2, 3, 4, 5, 14)

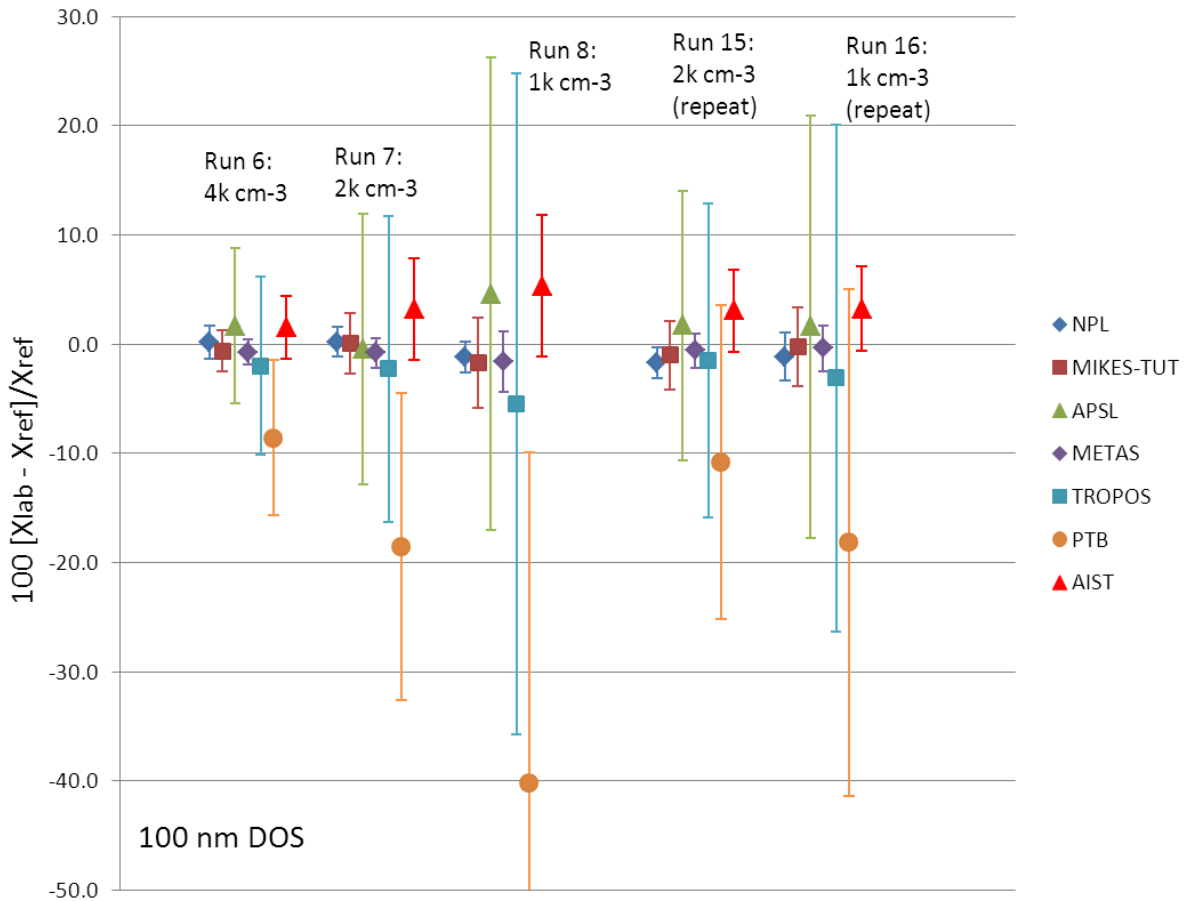

Figure 3. 100 nm DOS at a range of lower concentrations (Runs 6, 7, 8, 15, 16)

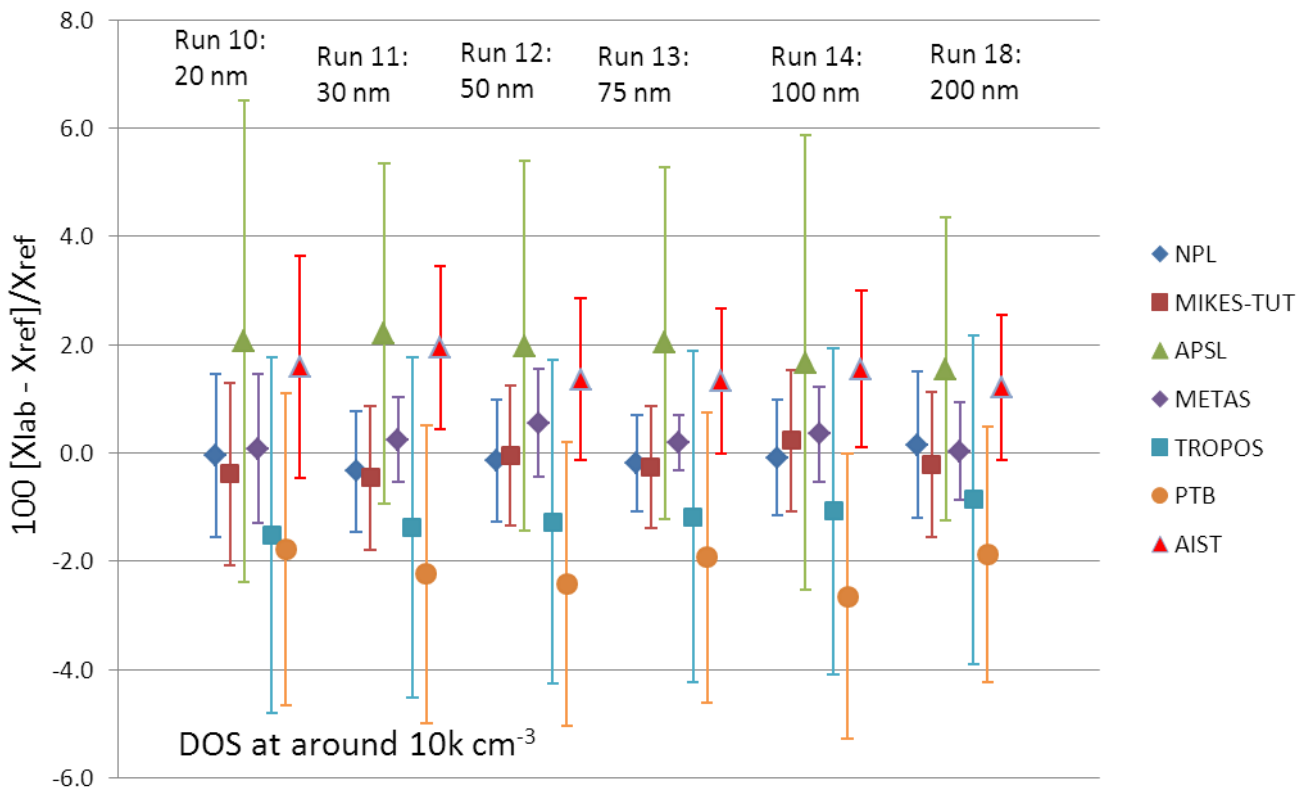

Figure 4. DOS at similar concentrations, with sizes from 20 to 200 nm (Runs 10, 11, 12, 13, 14, 18)

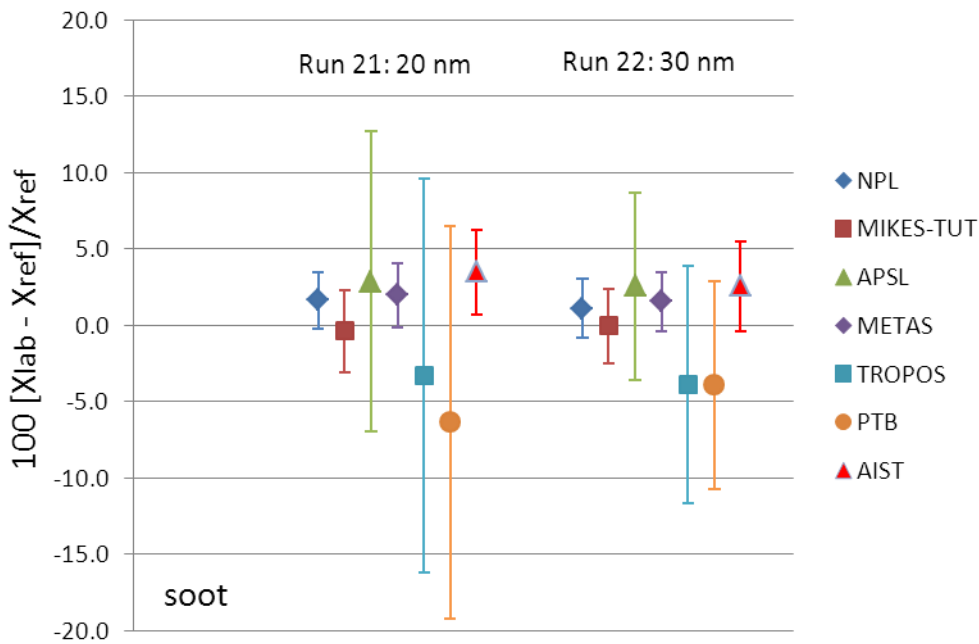

Figure 5. 20 and 30 nm soot particles, at concentrations of about 2.5k and 4k cm^{-3} respectively (Runs 21 and 22)

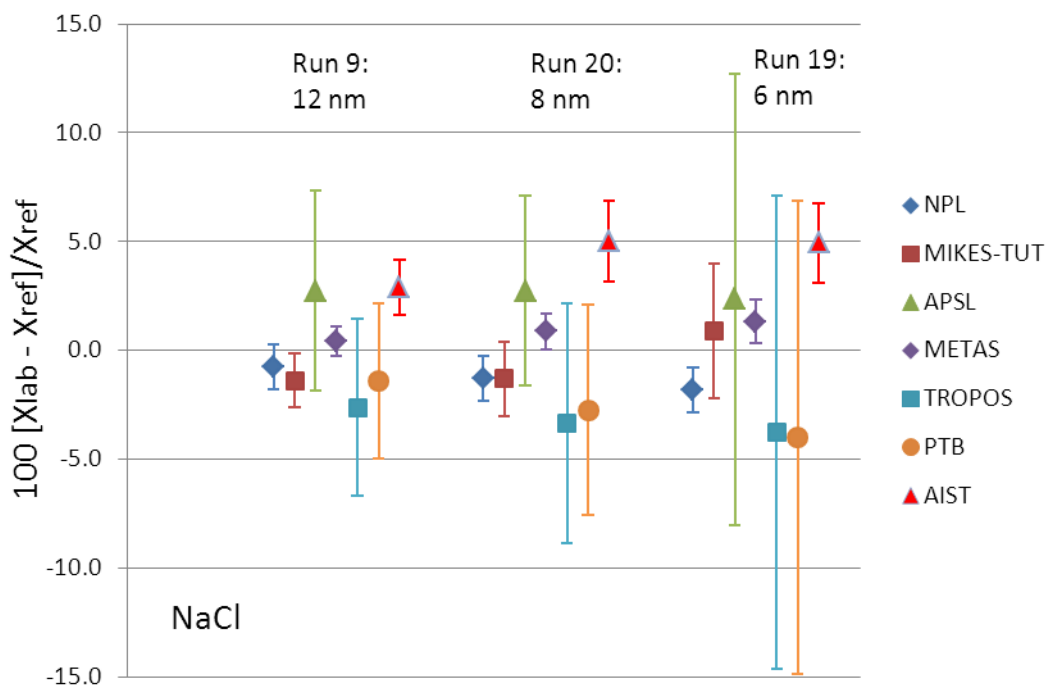

Figure 6. NaCl particles, at sizes 12, 8 and 6 nm, at concentrations of about 10k, 7.5k and 4k cm^{-3} respectively (Runs 9, 19, 20)

4. DISCUSSION AND CONCLUSIONS

4.1. SUMMARY OF RESULTS

Given that this is the first such comparison of aerosol electrometers, the results provide information relating to many aspects of these measurements. For example, they show whether it is practical to conduct a metrological comparison by simultaneous sampling; what limits there may be in practice to the particle number concentrations and sizes that can be used; whether there is a significant effect from using different materials; what the currently achievable level of agreement between independent laboratories with different designs of instrument is; and whether uncertainties being assigned to the measurements are realistic.

Taking these points in turn, TUT had demonstrated prior to the comparison that, after careful design and construction, aerosol concentrations measured by the same instrument at different ports agreed to within less than 1% at all eight ports, at sizes above 20 nm. This is supported by the results, and the methodology therefore appears suitable for such comparisons.

Difficulties are expected at low charge concentrations (where the measured currents are in the low fA range), and at low sizes, where instrument-dependent diffusion losses will occur. The results in Figures 2 and 4 show remarkably consistent performances by all these instruments over the concentration range from about 1 to 3 fC.cm⁻³, and in the particle size range from 20 to 200 nm. Lower concentrations (down to about 0.15 fC.cm⁻³), Figure 3, showed increased variations, but still good agreement in most cases.

The results for particle sizes below 20 nm, when significant losses from diffusion are expected, shown in Figure 6, need to be interpreted with caution. As set out in Appendix 2, some laboratories, such as AIST, corrected their readings for size-dependent internal losses, while others, like NPL, did not. It is therefore likely that the comparison reference values here are biased low by the laboratories with uncorrected internal losses. There is also a higher chance that the concentrations at different ports are less consistent due to small differences in the pathways to the different instruments or in the inlet flow rates of the instruments.

The limited number of results with soot particles (Figure 5) indicate that comparable results can be obtained using different particle materials and less specialised particle sources, though more variation between laboratories was observed.

Results such as those in Figure 4 suggest that agreement to $\pm 3\%$ between reference laboratories using different designs of instrument is already typical, and that uncertainties of less than $\pm 1\%$ (2σ) are achievable.

4.2. SUPPORTED CMC CLAIMS

It is proposed that this comparison can be used to support CMC claims for aerosol electrometer calibrations in the range 1 to 3 fC.cm⁻³.

5. REFERENCES

- [1] ISO/DIS 27891: Aerosol particle number concentration — Calibration of condensation particle counters.

- [2] Yli-Ojanperä, J., Mäkelä, J.M., Marjamäki, M., Rostedt, A., Keskinen, J. (2010) Towards traceable particle number concentration standard: Single charged aerosol reference (SCAR). *Journal of Aerosol Science* **41**, 719-728.

- [3] Högström, R., Yli-Ojanperä, J., Rostedt, A., Iisakka, I., Mäkelä, J. M., Heinonen, M. and Keskinen, J., (2011) Validating the single charged aerosol reference (SCAR) as a traceable particle number concentration standard for 10 nm to 500 nm aerosol particles, *Metrologia* **48**, 426–36.

APPENDICES

APPENDIX A1 – EURAMET 1244 PROTOCOL

EURAMET 1244

Comparison of aerosol electrometers

Coordinating Laboratory: NPL, UK
Host: Tampere University of Technology, Finland

Protocol

1. Background

Aerosol particle number concentration has recently featured in vehicle emission legislation and is becoming increasingly important in other areas such as ambient air monitoring. Number concentration measurements are also often integral to particle size distribution measurements, such as when using a Scanning Mobility Particle Sizer.

The draft ISO standard ISO/CD 27891 describes a calibration procedure for Condensation Particle Counters (CPCs - the usual type of instrument for measuring particle number concentration in the size range from a few nanometers to a few micrometers) by reference to an aerosol electrometer. If a source of singly-charged particles is used, number concentration (typically in units of cm^{-3}) is directly comparable to charge concentration (eg in $\text{C}\cdot\text{cm}^{-3}$). The CD refers to the role of NMIs in providing certification for reference aerosol electrometers and reference CPCs.

Although not strictly a chemical measurement, the comparison belongs in the Gas subcommittee of TC-MC because of the similarity to gas concentration measurements, following the precedent of earlier projects 893 (workshops to establish “Metrology infrastructure for airborne nanoparticles”) and 1027 (“Comparison of combustion particle number concentration and size”).

The aim of this comparison is to compare the results of different laboratories’ measurements of charge concentration – in practice the combination of electrometer current (eg in fA), air flow (in $\text{cm}^3\cdot\text{s}^{-1}$) and any losses of particles within the instrument.

Because this is the first multi-NMI comparison of aerosol electrometers, EURAMET participants are being joined by other participants with expertise in this area.

1. Comparison protocol

The comparison will be held at the Tampere University of Technology in Finland during the week 18-22 March 2013.

Participants will be responsible for the transport of their instruments to and from Tampere, and for their setting up and operation. This includes the calibration of electrometers and flow meters, and the collection of data.

The electricity supply at Tampere is 230V 50Hz with CEE 7/4 socket (plug type F). Participants must provide their own electrical adaptors if necessary.

Participants must sample the test aerosol (particles+nitrogen) at approximately 1 litre/min (at 25°C and 101.3 kPa), and are expected to take readings every second. Participants' electrometer inlets must be ¼-inch metal tube. The outlet connection of each electrometer (i.e. connection to the vacuum line, if needed) should be either a 6 mm Swagelok tube connector or a 6 mm tube. Participants must provide their own adaptors if needed.

Particles will be mainly from the SCAR generator (approximately 12 nm-sized NaCl particles, singly-charged then grown with di-octyl sebacate to be larger, singly-charged particles), with an additional run with monomobile aerosol containing multiply-charged particles using either a soot generator or an atomizer (NaCl particles). The size range will be around 20 to 100 nm, and the concentration range around 0.16 to 1.6 fC.cm⁻³ (equivalent to around 1 000 to 10 000 particles cm⁻³). The comparison scheme consists of 12 runs (at minimum), the nominal values of which are shown in the Table:

size conc.	20 nm	30 nm	40 nm	50 nm	100 nm
10 000 /cm ³	1e, multiple charged	1e, multiple charged	1e	1e	1e
8 000 /cm ³					1e
6 000 /cm ³					1e
4 000 /cm ³					1e
2 000 / cm ³					1e
1 000 / cm ³					1e
0 / cm ³					

Table 1. Sizes and concentrations to be included in the comparison

The measurement period for each run will last for 31 minutes. During each measurement period the Faraday cup aerosol electrometers will sample 16, one minute long periods of zero concentration and 15, one minute long periods of nominal calibration concentration (e.g 1000 particles/cc). This is demonstrated in Fig. 1.

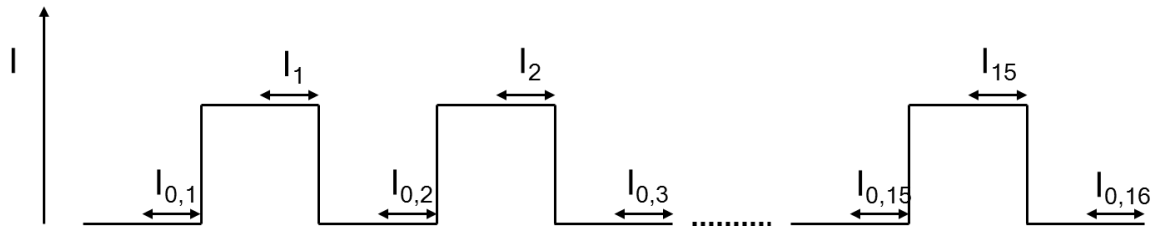

Figure 1. Actual measurement cycle as seen by the FCAEs.

An estimate for the actual particle concentration during a single measurement cycle (1 min zero-1 min particles-1 min zero, 15 in total) is then calculated by subtracting the average value of the two neighboring zero concentration periods from the nominal calibration concentration period in between as presented in Eq. 1.

$$\Delta I_k = I_k - \frac{I_{0,k} + I_{0,k+1}}{2} \quad (1)$$

After each sudden concentration change, the instruments need some time to stabilize. Therefore, in each of the 60 s periods, the average values are calculated by using data only from the last 30 s. As a result, the average electric current induced by the particles during a 31 minute measurement period is then calculated as an average of 15 electric current values as follows.

$$\Delta I = \frac{\sum_{k=1}^{15} \left(I_k - \frac{I_{0,k} + I_{0,k+1}}{2} \right)}{15} \quad (2)$$

In order to be suitable for the above measurement routine, all electrometers must settle in less than 30 s after a sudden concentration change.

The schedule for the week is expected to be:

- Day 1: Unpacking, assembling and testing of equipment
- Day 2-3: Comparison at different concentrations
- Day 3-4: Comparison at different particle sizes
- Day 4: Measurement using multiply charged particles, data processing
- Day 5: Packing, Preliminary results and leaving

On each day, some time will be reserved for data processing.

Reporting of the results

Preliminary results during the campaign

One aim for the comparison is to report the results in a scientific publication in which all participating institutes are expected to participate. With this in mind, to maximize the use of

the time available, each campaign day will end with a data processing and discussion session in which each institute calculates their preliminary results from that day's measurements and submits them to the coordinating and host laboratories.

Final results

The final results are to be reported, with volume corrected to standard conditions, on the pro-forma sheets attached. It is expected that these will be submitted by participants after they have returned to their laboratories to allow subsequent checks on the equipment.

Any significant changes from the preliminary results need to be justified with the relevant data.

Participating laboratories should specify the method and calibration procedure used for the comparison in detail. They should also state the route through which the calibration procedure provides traceability to the SI.

The expanded uncertainty for each measurement should also be calculated. Information should be provided about how the uncertainty budget was calculated.

NPL and TUT together will be responsible for collecting and reporting measurement results.

Points of contact:

General contacts and reporting of the results for the comparison
paul.quincey@npl.co.uk
jaakko.yli-ojanpera@tut.fi

Please also copy all e-mail correspondence to

dimitris.sarantaridis@npl.co.uk

APPENDIX A2 – PARTICIPANTS RESULTS PROFORMAS

EURAMET 1244 – Comparison of aerosol electrometers
Tampere University of Technology 18-22 March 2013

Results Proforma (revised 21 March 2013)

Participant laboratory, and people involved:

NPL
Paul Quincey
Dimitris Sarantaridis

Model / origin of aerosol electrometer:

GRIMM FCE model:5.705

Method of flow control:

Volumetric flow control.
Flow measured at the start and end of every experimental day, using mass flow meter MKS 179A and T, P conditions provided by the lab's facilities at Tampere University.

Calibration methods and traceability:

GRIMM FCE: Calibration performed using a voltage source (Keithley 213), a 1 GOhm standard resistor (Welwyn) traceable to NPL primary standards of resistance, and a voltmeter (HP 3458A) traceable to NPL primary standards of voltage.

MKS mass flow meter: Calibration performed by determining mass loss from a cylinder of synthetic air during a measured time interval. Traceability to NPL mass standards.

Deviations from the data processing protocol, excluding spike removal: (eg if the last 30 seconds of each minute period were not averaged, which data points were averaged? How was Run 6 handled?)

In Run 6 the average of 13 currents was used (I3 to I15).

Method used for outlier (spike) removal (if any):

Spikes were removed only from Run 1, by not including them in the 30s averaging. Eight spikes removed in total in Run 1 using personal judgment.

Are the aerosol electrometer readings corrected for size-dependent internal losses?

No

Reasons for changes from the provisional results submitted during the comparison: (eg flow correction, spike removal, recalibration of electrometer – reasons for each individual result are not required)

The following changes have contributed to the change of values originally submitted:

1. Recalibration of the FCE, with the average factor of pre-Tampere and post-Tampere calibration used in the final results.
2. In the preliminary results the last 15s of every minute-run were averaged, whereas in the final results the average of the last 30s of every minute-run was taken, as required.
3. In the preliminary results only the flow measured at the beginning of every day was used, whereas the final concentrations reported have been calculated for the average flow measured at the beginning and end of every experimental day.
4. Spike removal in Run 1, as described above.

Components included in the uncertainty calculation:

1. Electrometer random uncertainty: standard deviation of the mean current measurement for every run.
2. Electrometer flow rate random uncertainty.
3. Flow meter calibration uncertainty.
4. Electrometer current calibration uncertainty.
5. Temperature correction uncertainty.
6. Pressure correction uncertainty.

No uncertainty component has been included for size-dependent internal losses.

Run designation	Result (fC.cm ⁻³ at 25°C and 101.3 kPa)	Measurement uncertainty (95% confidence) (fC.cm ⁻³)	Number of outlier points removed ¹
1	0.000	0.0005	8
2	2.770	0.031	
3	1.514	0.017	
4	1.213	0.013	
5	1.182	0.013	
6	0.591	0.009	
7	0.300	0.004	
8	0.137	0.002	
9	1.168	0.012	
10	1.460	0.022	
11	1.522	0.017	
12	1.605	0.018	
13	1.567	0.014	
14	1.592	0.017	
15	0.287	0.004	
16	0.179	0.004	
18	1.785	0.024	
19	0.379	0.004	
20	0.860	0.009	
21	0.332	0.006	
22	0.625	0.012	

Date results submitted: 21 May 2013

¹ Total number of seconds of data removed from the periods (both zero and "test" concentration) used to calculate the result, ie from a total of typically 30 x 31 = 930 seconds in each run.

EURAMET 1244 – Comparison of aerosol electrometers Tampere University of Technology 18-22 March 2013

Results Proforma (revised 21 March 2013)

Participant laboratory, and people involved:

Centre for Metrology and Accreditation (MIKES), Richard Högström
Tampere University of Technology (TUT), Aerosol physics laboratory, Jaakko Yli-Ojanperä

Model / origin of aerosol electrometer:

Faraday cup: Self-made
Electrometer: Keithley 6430 Sub-femtoampere remote sourcemeter
Mass flow controller: Alicat Scientific, MC-2SLPM-D/5M

Method of flow control:

Mass flow rate was controlled/measured with a mass flow controller at the FCUP outlet

Calibration methods and traceability:

Electrometer calibration and traceability:

The current measurement function of the electrometer was calibrated with a current source based on a high value reference resistor and a direct voltage source. Traceability of the reference resistor is based on a calibration chain starting from MIKES Quantum-Hall resistance standard. Traceability of the Fluke 5440B direct voltage source is based on a calibration chain starting from MIKES Josephson direct voltage standard

Mass flow meter calibration and traceability:

The flow meter was calibrated against the LFE calibration system. The operation of the LFE is based on laminar flow elements (molbloc, DH Instruments) and it is calibrated against the dynamic weighing system (DWS1). The operation of the DWS1 is based on dynamic gravimetric weighing of a gas vessel. Therefore, mass flow measurements are traceable to the definitions of mass and time.

The electrometer and the mass flow meter were calibrated before the campaign.

Deviations from the data processing protocol, excluding spike removal:

Data processing was performed according to protocol, i.e. the last 30s of each one minute current measurement of zero/signal was included in the calculation.

RUN 6: Last 13 cycles were included (i.e. first two cycles were omitted).

Method used for outlier (spike) removal (if any):

Data values deviating more than 3 times the standard deviation from the mean of each 30 s

dataset were removed.

Are the aerosol electrometer readings corrected for size-dependent internal losses?

Results were corrected for diffusion losses in the inlet tube of the FCUP.

Reasons for changes from the provisional results submitted during the comparison: (eg flow correction, spike removal, recalibration of electrometer – reasons for each individual result are not required)

Final results include calibration corrections for the flow meter and electrometer, diffusion corrections and spike removal.

Components included in the uncertainty calculation:

Electrometer calibration correction, type B.

Flow meter calibration correction, type B.

Standard deviation of the mean calculated from the bias corrected current values of the cycles, type A

Diffusion correction, type B (negligible)

Run designation	Result (fC.cm ⁻³ at 25°C and 101.3 kPa)	Measurement uncertainty (95% confidence) (fC.cm ⁻³)	Number of outlier points removed
1	0.0028	0.0153	5
2	2.7242	0.0314	0
3	1.5027	0.0188	4
4	1.2045	0.0153	3
5	1.1754	0.0149	15
6	0.5863	0.0110	1
7	0.2996	0.0082	1
8	0.1363	0.0057	4
9	1.1604	0.0147	2
10	1.4553	0.0246	2
11	1.5202	0.0204	5
12	1.6065	0.0209	5
13	1.5660	0.0176	3
14	1.5970	0.0209	0
15	0.2890	0.0092	0
16	0.1807	0.0065	4
17			
18	1.7784	0.0239	0
19	0.3894	0.0120	3
20	0.8599	0.0148	5
21	0.3254	0.0088	6
22	0.6179	0.0152	1

Date results submitted:

24 May 2013

EURAMET 1244 – Comparison of aerosol electrometers Tampere University of Technology 18-22 March 2013

Results Proforma (revised 21 March 2013)

Participant laboratory, and people involved:

U.S. Army Primary Standards Laboratory (APSL), Miles Owen
Electrometer operated by Dimitris Sarantaridis of the National Physical Laboratory, UK.

Model / origin of aerosol electrometer:

TSI, Inc. 3068B aerosol electrometer

Method of flow control:

Critical orifice

Calibration methods and traceability:

Electrometer traceability:

Two methods are used to calibrate the 3068B aerosol electrometer:

1. Keithley 6430 reference current source is used to measure linearity. The Keithley 6430 is calibrated with traceability to the National Institute of Standards and Technology (NIST) by manufacturer using voltage and resistance standards.
2. A custom current source made of a high resistor and low voltage source. Both the resistor and voltage source are calibrated with NIST traceability, and current leakage uncertainties are estimated.

Flow meter traceability:

The Bios Defender 510-M volumetric flow meter is calibrated with a transfer standard laminar flow element (molbloc, DH Instruments) that measures mass flow rate, along with pressure and temperature measurements to calculate a volumetric flow rate.

The transfer standard laminar flow element (molbloc, DH Instruments) is calibrated with traceability to NIST using a gravimetric flow standard (GFS, DH Instruments). The GFS is a primary standard gravimetric system that measures mass loss of a bottle of gas over time to give mass flow rate. Pressure and temperature are monitored for buoyancy correction, and the APSL mass laboratory provides a calibrated check weight. All measurements of mass, time, pressure, and temperature are traceable to NIST.

Deviations from the data processing protocol, excluding spike removal: (eg if the last 30 seconds of each minute period were not averaged, which data points were averaged? How was Run 6 handled?)

The first two current measurements from Run 6 were excluded from the averaging, as instructed to do so by Dimitris Sarantaridis. This is listed as 120 seconds of data removal from Run 6 in the table below.

Method used for outlier (spike) removal (if any):

None

Are the aerosol electrometer readings corrected for size-dependent internal losses?

No.

Reasons for changes from the provisional results submitted during the comparison: (eg flow correction, spike removal, recalibration of electrometer – reasons for each individual result are not required)

The calibration factor for the electrometer current measurement used in the calculations for this proforma is 0.9941, as opposed to the factor 0.9911 that appeared to be used in the preliminary analysis.

The volumetric flow rates used to calculate the results for this proforma were corrected to 101.3 kPa and 25 °C using the actual pressure and temperature of the test aerosol for each measurement.

Components included in the uncertainty calculation:

1. Uncertainty in electrometer current measurement, type B.
2. Uncertainty in electrometer inlet flow rate for each day, type B.
3. Electrometer noise, type A.
4. Pressure and temperature uncertainty, type A (negligible).

Run designation	Result (fC.cm ⁻³ at 25°C and 101.3 kPa)	Measurement uncertainty (95% confidence) (fC.cm ⁻³)	Number of outlier points removed
1	0.001	0.025	0
2	2.766	0.082	0
3	1.529	0.051	0
4	1.223	0.043	0
5	1.191	0.045	0
6	0.600	0.042	120
7	0.298	0.037	0
8	0.145	0.030	0
9	1.209	0.054	0
10	1.491	0.065	0
11	1.561	0.048	0
12	1.639	0.055	0
13	1.602	0.051	0
14	1.620	0.067	0
15	0.297	0.036	0
16	0.184	0.035	0
18	1.810	0.050	0
19	0.395	0.040	0
20	0.895	0.038	0
21	0.336	0.032	0
22	0.634	0.038	0

Date results submitted:

23 May 2013

EURAMET 1244 – Comparison of aerosol electrometers Tampere University of Technology 18-22 March 2013

Results Proforma (revised 21 March 2013)

Participant laboratory, and people involved:

METAS, Felix Lüönd

Model / origin of aerosol electrometer:

TSI 3068B, METAS laboratory

Method of flow control:

Internal flow control via solenoid valve. The aerosol flow was measured externally with a Vögtlin Red-y flow meter (GSM-B4PA-BN00) downstream the solenoid valve. From Run 9 on, a needle valve was used between the flow meter and the vacuum pump in order to increase the operating pressure of the flow meter from 33 mbar to 270 mbar. An additional calibration of the flow meter with N₂ was performed to correct the measured flow to the experimental conditions.

Calibration methods and traceability:

Current: The electrometer was electrically calibrated at METAS prior to the workshop. In this calibration, currents between 10 fA and 1 pA were applied to the electrometer. The reference current was generated with a precisely controlled voltage ramp and a reference capacitance with low frequency dependence.

Flow rate: The used mass flow meter has been calibrated with the METAS primary reference standard at 0.92 lpm (at 1013 mbar and 273 K) between 98 mbar and 960 mbar absolute pressure. For those measurements where the flow meter was operated at 33 mbar absolute pressure instead of 270 mbar, the calibration was extrapolated. For more information see the document on data evaluation.

Deviations from the data processing protocol, excluding spike removal: (eg if the last 30 seconds of each minute period were not averaged, which data points were averaged? How was Run 6 handled?)

- Run 6: Only the last 13 cycles were evaluated.
- Run 10: Since the signal over the 15 cycles exhibited a drift, the charge concentration was calculated for each cycle individually, and the average over the 15 cycles was taken subsequently.
- Run 12: Due to data recording problems, only 14 cycles were evaluated.

Method used for outlier (spike) removal (if any):

Data points deviating by more than 3 standard deviations from the average “on” or “off” value (i.e. with or without particles, respectively) were removed from the sample. As an exception, data were only removed from Run 10, if they deviated from the average by more than 5 standard deviations, due to the drift in the signal.

Are the aerosol electrometer readings corrected for size-dependent internal losses?

No.

Reasons for changes from the provisional results submitted during the comparison: (eg flow correction, spike removal, recalibration of electrometer – reasons for each individual result are not required)

Overall, the charge concentration values are slightly lower than the preliminary results provided during the workshop due to a recalibration of the mass flow meter at the corresponding absolute pressure. The effect is small for Run 9 – 22 (flow meter at 270 mbar absolute pressure), but around 3% for Run 1 – 8 (flow meter at 33 mbar)

Components included in the uncertainty calculation:

Flow rate: Type B contribution according to the flow meter calibration, and a Type A contribution according to the fluctuation in measurement.

Current: Type A contribution according to the fluctuation in the measurement. No Type B contribution, since the uncertainty specified in the calibration of the electric current is dominated by fluctuations as well. For details please refer to the document about data evaluation.

As the flow was measured externally with a mass flow meter, no pressure or temperature measurements enter the formula for the calculation of the charge concentration.

Run designation	Result (fC.cm ⁻³ at 25°C and 101.3 kPa)	Measurement uncertainty (95% confidence) (fC.cm ⁻³)	Number of outlier points removed
1	-0.0032	0.0038	12
2	2.718	0.02	6
3	1.502	0.012	13
4	1.205	0.008	10
5	1.174	0.012	7
6	0.5858	0.0070	8
7	0.2969	0.0040	14
8	0.1364	0.0038	13
9	1.182	0.008	8
10	1.462	0.02	6
11	1.531	0.012	5
12	1.616	0.016	5
13	1.573	0.008	19
14	1.599	0.014	7
15	0.2903	0.0046	10
16	0.1804	0.0038	2
17	n.a.	n.a.	n.a.
18	1.783	0.016	4
19	0.3911	0.0038	10
20	0.879	0.0072	10
21	0.333	0.0068	8
22	0.6277	0.012	5

Date results submitted:

29. 04. 2013

EURAMET 1244 – Comparison of aerosol electrometers Tampere University of Technology 18-22 March 2013

Results Proforma (revised 21 March 2013)

Participant laboratory, and people involved: TROPOS, Dr. Thomas Tuch

Model / origin of aerosol electrometer: TSI 3068 B S/N 70838596

Method of flow control: Volumetric Flow Controller

Calibration methods and traceability: PTB fA source, PTB flow standard

Deviations from the data processing protocol, excluding spike removal: (eg if the last 30 seconds of each minute period were not averaged, which data points were averaged? How was Run 6 handled?)

Method used for outlier (spike) removal (if any): Filled up with measurements prior to scheduled 30 seconds

Are the aerosol electrometer readings corrected for size-dependent internal losses? no

Reasons for changes from the provisional results submitted during the comparison: Correction of measured current according to PTB calibration, flow correction according to PTB calibration.

Components included in the uncertainty calculation:

Uncertainty budget EM TSI 3068 B, S/N 71133020, current measurement, k=2:

$$I = I_{\text{display}} \cdot \prod_i Q_i$$

$$I = I_{\text{display}} \cdot Q_{\text{calibration}} \cdot Q_{\text{offset}} \cdot Q_{\text{other}}$$

$Q_{\text{calibration}}$ (short term stability, non linearity, noise, display resolution, offset during calibration)

Q_{offset} (Offset during measurement)

Q_{other} (long term stability, temperature, rH), not used, not sufficient data

$$Q_{\text{offset}} = 1 - I_{\text{offset}} / I_{\text{display}}$$

$$u(I_{\text{offset}}) = 0,5 \cdot 0,001 \text{ pA} \cdot 2 / \sqrt{3}$$

$$u(Q_{\text{offset}}) = u(I_{\text{offset}}) / I_{\text{display}}$$

from the manual: accuracy $\pm 2\%$ or $\pm 5 \text{ pA}$ whichever is bigger.

$$u(Q_{\text{other}}) = 2 \cdot \text{Max}(0,02; 0,005 \text{ pA} / I_{\text{display}}) / \sqrt{3}$$

$$Q_{\text{sother}} = 1$$

$$Q_{\text{calibration}} = y_1 + y_2 (I'_{\text{display}} - I_0)$$

y_1 : intercept

y_2 : slope

I'_{Anzeige} : offset corrected display

I_0 : center of calibration (-> $r_{y_1, y_2} = 0$)

$$I'_{\text{display}} = I_{\text{display}} \cdot Q_{\text{offset}} = I_{\text{display}} - I_{\text{offset}}$$

$$Q_{\text{calibration}} = y_1 + y_2 (I_{\text{display}} - I_{\text{offset}} - I_0)$$

Run	Result (fC.cm ⁻³ at 25°C and 101.3 kPa)	Measurement uncertainty (95% confidence) (fC.cm ⁻³)	Numer of points removed
1	0.00206228	0.03599928	15
2	2.69556024	0.05399892	0
3	1.49671017	0.04799904	8
4	1.19066594	0.04799904	7
5	1.17660776	0.04799904	6
6	0.5783114	0.04799904	25
7	0.29256032	0.04199916	0
8	0.13105131	0.04199916	35
9	1.1459755	0.04799904	29
10	1.43871287	0.04799904	16
11	1.50612772	0.04799904	18
12	1.58667582	0.04799904	13
13	1.55149125	0.04799904	16
14	1.57628841	0.04799904	31
15	0.28762858	0.04199916	36
16	0.17552648	0.04199916	31
18	1.76703836	0.05399892	7
19	0.37150759	0.04199916	31
20	0.84202934	0.04799904	7
21	0.3158873	0.04199916	31
22	0.59442197	0.04799904	9

Date results resubmitted: 10.06.2013

Reason for resubmission: In runs 6,7,8,15,16 raw data had been used for previous calculations. Data from the wrong cell of the worksheet had been copied into the result sheet.

EURAMET 1244 – Comparison of aerosol electrometers Tampere University of Technology 18-22 March 2013

Results Proforma (revised 21 March 2013)

Participant laboratory, and people involved:

PTB, Andreas Nowak (calibration at TUT), Anke Jordan-Gerkens (uncertainty budget), Gerd-Dietmar Willenberg (calibration of electrical signal for TSI 3068 B)

Model / origin of aerosol electrometer:

TSI 3068 B, S/N 71133020

Method of flow control:

The flow for TSI 3068 B during the intercomparison workshop we don't monitored, but we check each morning the flow arte against flow meter of TUT and adjusted the flow to 1.002 l/min (inter flow of TSI 3068 B at 0.98, display reading). When an uncertainty budget for the flow calibration is needed, a calculation for uncertainty of TUT flow meter is recommended.

Calibration methods and traceability:

The charging of capacity was measured. The method is traceable for SI units F, V and s.

Deviations from the data processing protocol, excluding spike removal: (eg if the last 30 seconds of each minute period were not averaged, which data points were averaged? How was Run 6 handled?)

For each run we used a mean average for all intervals separated in minimum (zero value) and maximum interval (set value)

Method used for outlier (spike) removal (if any):

The quantile method was used to remove outliers for each interval.

Are the aerosol electrometer readings corrected for size-dependent internal losses?

No correction was implemented so far. Maybe we should use same procedure for each TSI 3068 B?

Reasons for changes from the provisional results submitted during the comparison: (eg flow correction, spike removal, recalibration of electrometer – reasons for each individual result are not required)

The electrical signal was recalibrated between 2 fA up to 1 pA.

Components included in the uncertainty calculation:

Several components are implemented in the uncertainty budget like short term stability, nonlinearity, noise ratio, display resolution, offset, humidity and temperature.

For uncertainty budget of electrometer we used the calculation for the short term stability, because we don't have experience so far about long term stability of electrometer. Until now, only one calibration of the electrical signal for the electrometer was realized at PTB.

Table 1:

Run designation	Result (fC.cm ⁻³ at 25°C and 101.3 kPa)	Measurement uncertainty (95% confidence) (fC.cm ⁻³)	Number of outlier points removed
run 1 (zero)	0.001925216		104
run 2	2.689451618	0.041999916	270
run 3	1.473995326	0.041999916	244
run 4	1.170075918	0.041999916	244
run 5	1.140887227	0.041999916	201
run 6	0.53938286	0.041999916	167
run 7	0.243883744	0.041999916	111
run 8	0.082916541	0.041999916	83
run 9	1.160453521	0.041999916	177
run 10	1.43486468	0.041999916	212
run 11	1.493170515	0.041999916	218
run 12	1.568283106	0.041999916	209
run 13	1.539774991	0.041999916	228
run 14	1.551209949	0.041999916	247
run 15	0.260417546	0.041999916	207
run 16	0.14826967	0.041999916	129
run 17 (zero)	0.000635639		10
run 18	1.749065115	0.041999916	262
run 19	0.370598768	0.041999916	160
run 20	0.847449079	0.041999916	175
run 21	0.305902886	0.041999916	175
run 22	0.594161453	0.041999916	155

Date results submitted: 11 June 2013

EURAMET 1244 – Comparison of aerosol electrometers Tampere University of Technology 18-22 March 2013

Results Proforma (revised 21 March 2013)

Participant laboratory, and people involved:

NMIJ (AIST), Hiromu Sakurai

Model / origin of aerosol electrometer:

TSI 3068B, S/N 70742060

Method of flow control:

The internal flow controller of the FCAE was used. It maintained the actual volumetric flow rate constant, nominally at 1 L/min.

Calibration methods and traceability:

- Calibrated against the primary standard of AIST for charge concentration
- The primary standard of AIST is calibrated for both current and volumetric flow rate with traceability to SI.

Deviations from the data processing protocol, excluding spike removal: (eg if the last 30 seconds of each minute period were not averaged, which data points were averaged? How was Run 6 handled?)

No deviations.

For Run #6, the 13 valid measurements were averaged.

Method used for outlier (spike) removal (if any):

No outlier removal performed.

Are the aerosol electrometer readings corrected for size-dependent internal losses?

Yes

Reasons for changes from the provisional results submitted during the comparison: (eg flow correction, spike removal, recalibration of electrometer – reasons for each individual result are not required)

The provisional results were corrected with the approximated detection efficiency of 0.97. The data provided in this document are corrected with the detection efficiencies that were obtained from the calibrations at AIST before and after the comparison.

Components included in the uncertainty calculation:

- uncertainty components for the calibrations with the AIST primary standard FCAE
 - current measurement
 - volumetric flow rate measurement
 - elementary charge (negligible)
 - particle losses in the inlet tube of the Faraday cup
 - filtration efficiency of the particle filter in the Faraday cup (negligible)
 - flow splitter bias correction factor
 - random effects

- variation between the calibrations before and after the measurement at TUT
- uncertainty due to flow rate variation between the calibrations at AIST and the measurement at TUT
- repeatability uncertainty for the 15 repeated measurements at TUT

Run designation	Result (fC.cm ⁻³ at 25°C and 101.3 kPa)	Measurement uncertainty (95% confidence) (fC.cm ⁻³)	Number of outlier points removed
1	0.009	0.006	0
2	2.779	0.036	0
3	1.531	0.022	0
4	1.226	0.016	0
5	1.188	0.017	0
6	0.599	0.017	0
7	0.309	0.014	0
8	0.146	0.009	0
9	1.211	0.015	0
10	1.484	0.030	0
11	1.557	0.023	0
12	1.629	0.024	0
13	1.591	0.021	0
14	1.618	0.023	0
15	0.301	0.011	0
16	0.187	0.007	0
18	1.804	0.024	0
19	0.405	0.007	0
20	0.915	0.016	0
21	0.338	0.009	0
22	0.634	0.018	0

Date results submitted:

10 June 2013

EURAMET 1244 – Comparison of aerosol electrometers Tampere University of Technology 18-22 March 2013

Results Proforma (revised 21 March 2013)

Participant laboratory, and people involved: JRC, Francesco Riccobono

Model / origin of aerosol electrometer: EL-5030, Ioner.

Method of flow control: MFC provided by MIKES (Serial No. M-13D006)

Calibration methods and traceability: The electrical signal of the electrometer is currently being calibrated by PTB, and the MFC was recently calibrated by MIKES.

Deviations from the data processing protocol, excluding spike removal: (eg if the last 30 seconds of each minute period were not averaged, which data points were averaged? How was Run 6 handled?)

Considering that every step is made of 60 data points (60 seconds), I averaged the data from sec 25 to sec 55 of each step.

In Run 6 only 26 steps were used instead of the usual 31.

Method used for outlier (spike) removal (if any):

A 5 seconds long moving average current value (in fA) was determined in each point; The point is considered an outlier (hence excluded from the calculation) if its value differs more than 2 fA from the moving average value.

Are the aerosol electrometer readings corrected for size-dependent internal losses?

No

Reasons for changes from the provisional results submitted during the comparison: (eg flow correction, spike removal, recalibration of electrometer – reasons for each individual result are not required)

There are minor changes (about 1-2%) from the provisional results submitted during the comparison due to an optimized spike removal procedure.

Components included in the uncertainty calculation:

Electrometer readings uncertainty

Electrometer flow rate uncertainty

MFC calibration uncertainty

Electrometer current calibration uncertainty

Temperature correction uncertainty

Pressure correction uncertainty

Run designation	Result (fC.cm ⁻³ at 25°C and 101.3 kPa)	Measurement uncertainty (95% confidence) (fC.cm ⁻³)	Number of outlier points removed
1	-0.0017	-0.0002	12
2	2.0891	0.0382	16
3	1.1518	0.0211	8
4	0.9164	0.0167	8
5	0.8973	0.0164	9
6	0.4446	0.0081	138
7	0.2257	0.0041	14
8	0.0998	0.0018	10
9	1.1027	0.0202	11
10	1.3182	0.0241	6
11	1.3480	0.0246	14
12	1.3127	0.0240	11
13	1.2217	0.0223	9
14	1.2083	0.0221	250
15	0.2183	0.0040	9
16	0.1309	0.0024	18
18	1.2816	0.0234	3
19	0.3455	0.0063	10
20	0.7982	0.0146	2
21	0.3037	0.0056	12
22	0.5470	0.0100	14

Date results submitted: 24 May 2013