

**An Intercomparison of the
Measurement Performance of
Five Small Water Flow
Calibration Facilities at Four
European Laboratories**

A Report for

**NMSPU
Department of Trade and Industry
151 Buckingham Palace Road
London, SW1W 9SS**

Project No: WSDC40

Report No: 310/99

Date: 9 September 1999

This report is issued as part of the contract under which the work has been carried out for the client.

NOTES

- 1 This report may be published in full by the client unless it includes information supplied in confidence by NEL or any third party. Such information, if included within the report, shall be separately designated as confidential by NEL.
- 2a The prior written consent of NEL shall be obtained by the client before publication by him or any extract from, or abridgement of, this report.
- 2b The prior written consent of NEL shall be obtained by the client before publication:
 - where such publication is made in connection with any public enquiry, legal proceedings or arbitration
 - where such publication is made in, or in connection with, any company prospectus or similar document
 - where the client has notice that NEL is seeking or intends to seek patent or like protection for any intellectual property produced in the course of rendering the services.

Flow Centre

National Engineering Laboratory
East Kilbride
Glasgow G75 0QU
Tel: 01355 220222
Fax: 01355 272999

**An Intercomparison of the Measurement Performance of
Five Small Water Flow Calibration Facilities,
at Four European Laboratories**

A Report for

**NMSPU
Department of Trade and Industry
151 Buckingham Palace Road
London, SW1W 9SS**

Prepared by: Mr J Williamson



Approved by: Mr R Paton

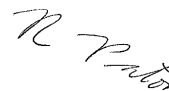

Date: 9 September 1999
for Dr F C Kinghorn
Director

CONTENTS

	<u>Page</u>
EXECUTIVE SUMMARY	4
1 INTRODUCTION	5
2 PROJECT OBJECTIVES	6
3 DESIGN OF TRANSFER STANDARD	6
4 COMMISSIONING OF TRANSFER STANDARD	10
5 ORGANISATION OF THE INTERCOMPARISON	10
5.1 Schedule of Calibration	11
6 RESULTS OF INTERCOMPARISON CALIBRATIONS	11
6.1 Measuring Principles and Methods Used	11
6.2 NEL1 (Initial) Calibrations	12
6.3 NEL2 Calibrations	13
6.4 WRc Calibrations	13
6.5 DTI, Denmark Calibrations	13
6.6 SP, Sweden Calibrations	13
6.7 NEL1 (Final) Calibrations	13
7 ANALYSES OF THE DATA	13
8 DISCUSSION OF RESULTS	14
8.1 Results from WRc and NEL, LCD Output.....	14
8.2 Comparison of 1.5 mm Meter Pulse Calibrations	16
8.3 Comparison of the 3 mm Meter Pulse Calibrations	18
8.4 Repeatability of Results.....	21
8.5 Ancillary Measurements	21
8.6 Uncertainties of the Calibration Facilities	22
8.7 Relationship to other Intercomparisons	22
9 CONCLUSIONS	23
ACKNOWLEDGEMENTS	24
REFERENCES	24

APPENDICES:

APPENDIX I: FLOWRATE RANGES OF BAILEY-FISCHER &
PORTER, 1, 1.5, 2 and 3 mm BORE COPA XM
FLOWMETERS

APPENDIX II: ASSEMBLY AND CALIBRATION GUIDANCE NOTES
FOR TRANSFER STANDARD

APPENDIX III: INTERCOMPARISON OF DATA FROM NEL, VERY
LOW FLOW, CALIBRATION FACILITY

APPENDIX IV: INDEX OF TABLES AND FIGURES IN CD-ROM,
NEL REPORT No 305/99

EXECUTIVE SUMMARY

A transfer standard for flowrates from 10 to 350 l/h has been designed, assembled and commissioned at NEL, Flow Centre.

The transfer standard was subsequently used in an international intercomparison of flow calibration rigs located in Denmark, Sweden and UK.

Analysis of the results shows agreement between the calibration rigs at two different levels dependant on the meter used.

Across the range 10 to 100 l/hr using the 1.5 mm meter, agreement within 1.5 per cent was achieved. Across the range 30 to 350 l/hr, agreement to within 0.7 per cent was found. No discernible difference could be attributed to a particular test laboratory or test method.

This is a major improvement on a previous EU intercomparison on hot water meters at low flowrates which in the same range achieved agreement using cold water to no better than 5 per cent.

The 1.5 mm and 3 mm bore, electromagnetic flowmeters, used in the transfer standard showed good repeatability of within 0.2 per cent generally within each calibration. No systematic change in calibration could be seen across the programme.

The project as a whole showed that agreement, although much improved, is still unacceptable from laboratories claiming 0.1 to 0.2 per cent uncertainty and a package with a repeatability of the same order. Any follow up project must however address the possible stability of the package.

All the data supplied by the participating laboratories and a full analysis of the data is contained in a CD-ROM, NEL Report No 305/99.

1 INTRODUCTION

A small transfer standard, comprising, one 1.5 mm and one 3 mm bore electromagnetic flowmeter with their respective converter units, was designed, assembled and commissioned at NEL.

The transfer standard was then sent for calibration to laboratories participating in an intercomparison of water flow calibration facilities. It was then returned to NEL where it was recalibrated.

The four participating Laboratories were:

Water Research Centre (WRc), Oakdale, Wales, UK,

Danish Technological Institute (DTI), Aarhus, Denmark

Swedish National Testing and Research Institute (SP), Boras, Sweden

National Engineering Laboratory (NEL), East Kilbride, UK

A third UK Laboratory was invited to participate but declined.

The Water Research Centre, Oakdale, is responsible for approving materials and components for use in the water industry.

The Danish Technological Institute, Aarhus, carries out research and development of flow and heat measurement systems and provides a calibration service for flow meters and heat meters in Denmark. It holds the Danish national standards for flow and heat measurement and has a regulatory function in approving metering systems.

The Swedish National Testing and Research Institute, Boras is the National Standards Laboratory for Sweden.

The National Engineering Laboratory (NEL) is an industrial research organisation concerned with many areas of mechanical engineering research. Within NEL, Flow Centre is the holder of the UK National Standards for Flow Measurement. Facilities exist for calibration and research involving water, oil, gas and multiphase flow. All the measurement components are fully traceable to Primary National Standards and most are accredited by United Kingdom Accreditation Service (UKAS).

The numerical analyses of the data from this project are presented in a condensed form in this report. Full details of the original data and the numerical analyses are contained in Microsoft Excel format, in NEL, report no. 305/99 entitled, 'Intercomparison Work for 1996-99 Flow Programme'. This report, which is issued as CD-ROM, also contains the results of other intercomparison studies carried out under the UK, Department of Trade and Industry, Flow Programme 1996 – 1999.

2 PROJECT OBJECTIVES

The objectives were:

- i) To design and commission a transfer standard suitable for auditing flow calibration rigs at small flowrates. In this case, the flowrates were from 10 to 350 l/h inclusive.
- ii) To use the transfer standard to audit a number of national calibration facilities in order to improve confidence in the measurements made by these flow facilities.
- iii) To identify the sources of any discrepancies found between the laboratories.

3 DESIGN OF TRANSFER STANDARD

Selection of suitable flowmeters for a transfer standard is critical. They must have stable performance under different influence factors, including the rigours of transportation from one location to another. They must have good repeatability, cover a wide range of flowrates and be durable.

The availability of good quality flowmeters for small flowrates is limited. Several measuring principles were considered, viz., turbine, piston, vane and electromagnetic. Based on previous experience and the availability of suitable meters, electromagnetic meters were chosen.

Only a small number of companies manufacture electromagnetic meters in the required sizes and it was decided to use a 1.5 mm and a 3 mm COPA-XM, flowmeter manufactured by Bailey-Fischer & Porter⁽¹⁾. Appendix I shows the relationship between the flowrate ranges of the 1, 1.5, 2 and 3 mm, COPA-XM, flowmeters.

Details of the 1.5 and 3 mm meters acquired for the transfer standard are as follows:

Flowmeter 1

Manufacturer:	Bailey-Fischer & Porter
Model:	COPA-XM, 10DX2312, DN1.5, PN10
Size:	1.5 mm nominal bore
Flow sensor Serial No.:	9705L1290/A1
Converter Serial No:	9705L1290/B1
Flowrate range used:	10 to 90 l/h
Uncertainty quoted:	0.2 per cent of flowrate

Flowmeter 2

Manufacturer:	Bailey-Fischer & Porter
Type:	COPA-XM, 10DX2312, DN3, PN10
Size:	3 mm nominal bore
Flow sensor Serial No.:	9706L1188/A1
Converter Serial No:	9705L1188/B1
Flowrate range used:	30 to 350 l/h
Uncertainty quoted:	0.2 per cent of flowrate

The standard, Bailey-Fischer & Porter, 1.5 and 3 mm flowmeters have different external constructions, one being a threaded connection and the other being a wafer type. In order to improve the overall appearance of the metering assembly and to standardise the installation arrangements, the manufacturer agreed to construct a special meter in the 3 mm size. This meter would have threaded connections, and have a similar appearance to the 1.5 mm meter.

The transfer standard, flowmeter assembly is shown in Figure 1 and its schematic layout is shown in Figure 2. Stainless steel pipes and fittings were used throughout and high quality, uniform bore, ball valves were installed upstream and downstream of each meter, both for isolating the meters and to prevent internal leakage past the selected meter during calibration.

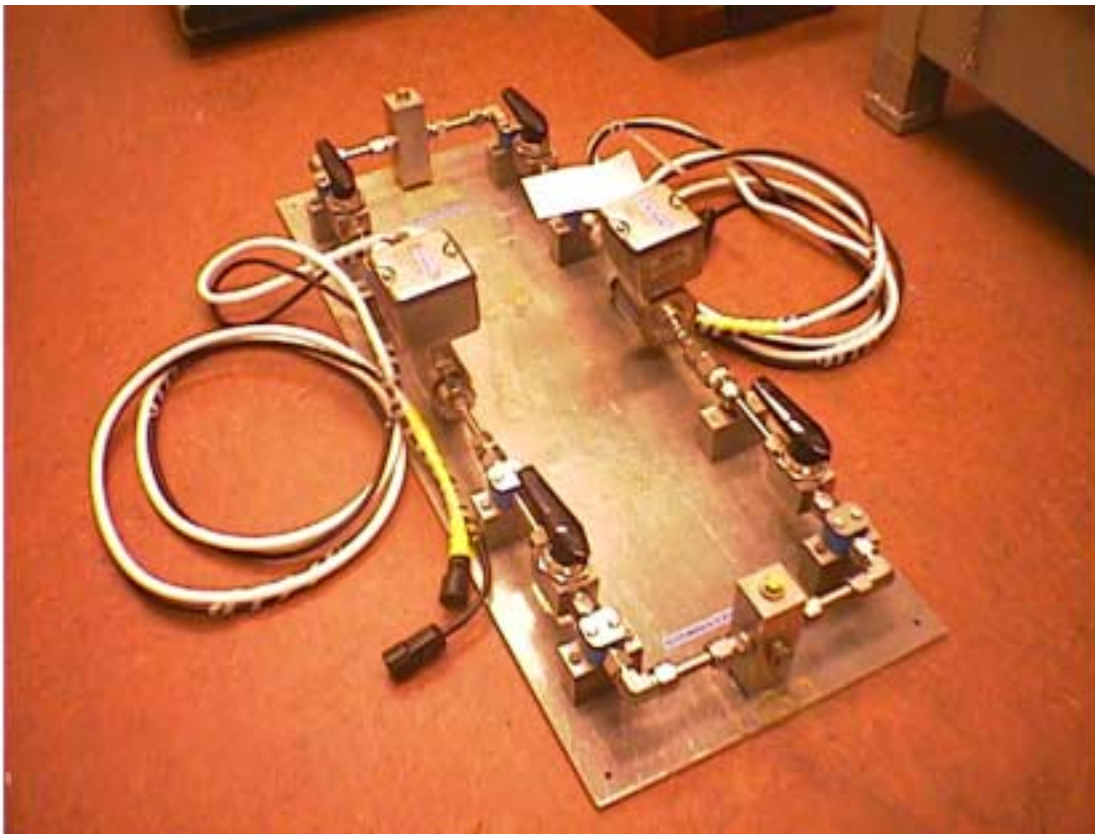

Fig 1 – View of low flow transfer standard, flowmeter assembly

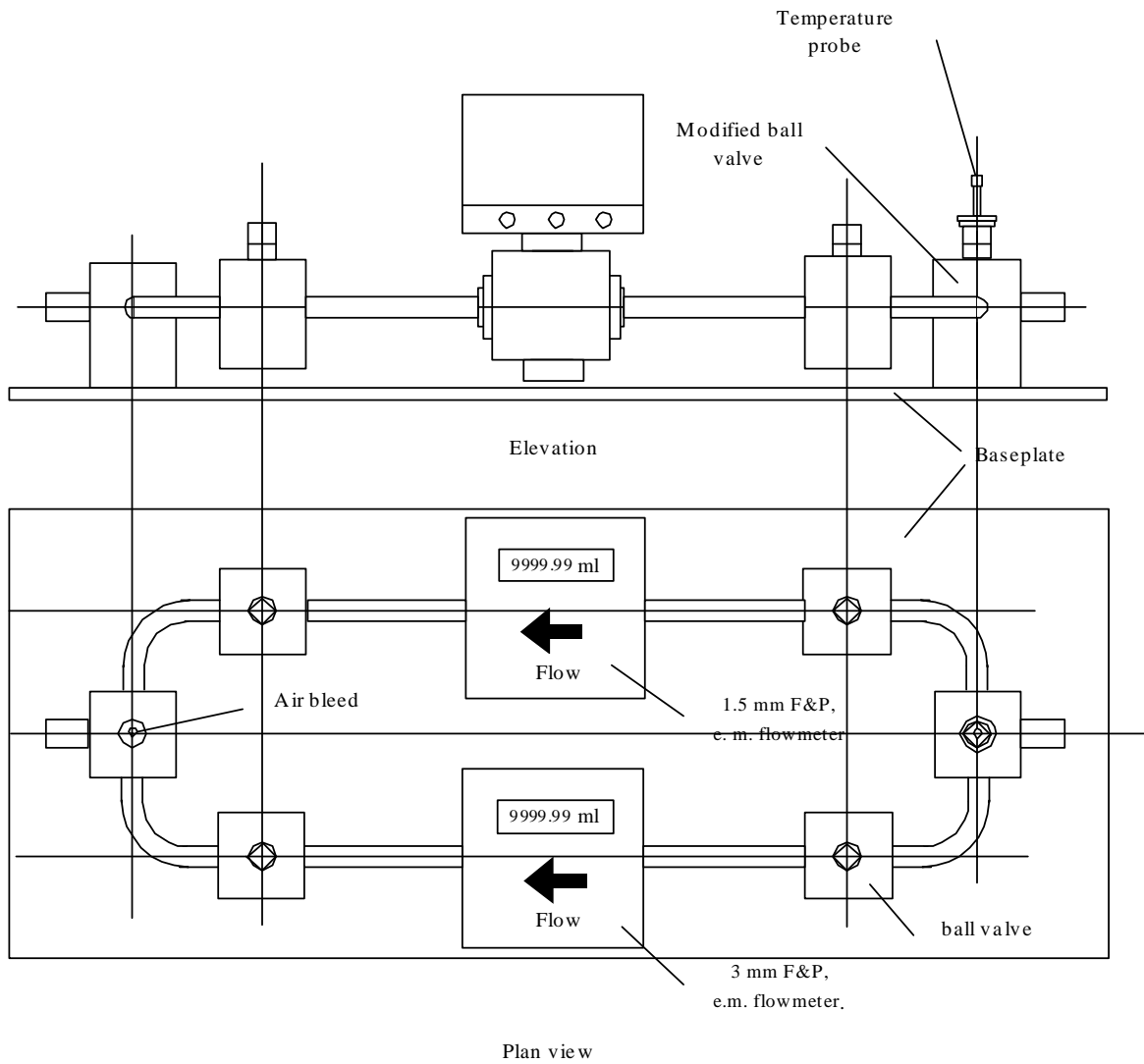

Figure 2 - Schematic diagram of low flow transfer standard

The flowmeter, converter unit assembly, is shown in Figure 3. This assembly incorporates the output signal connections for pulse and current measurements. The signal cables that connect with the meters are fitted with coded connectors to avoid the possibility of the cables being attached to the wrong converter units.



Figure 3 – View of flowmeter, converter unit assembly

The meter assembly and the converter units are installed in separate wooden boxes for transportation.

It was recognised that a variety of different measuring techniques and data collection methods, are in use by laboratories. These are summarised as follows:

- Standing-start-and-finish
- Flying-start-and-finish
- Volume tanks
- Weighing systems
- Meter provers
- Reference or master meters
- Manual reading of meter displays
- Electronic counting of meter output pulses
- Electronic counting, extended after the flow stops

Some facilities have the capability of using both standing-start-and-finish and flying-start-and-finish techniques whereas other laboratories may use only one or other of these techniques.

It was desirable to have as wide a spread of output options built into the flowmeters as possible, so that each laboratory could choose the method or methods it would normally use to calibrate the meters.

The 1.5 mm and 3 mm flowmeters chosen for the transfer standard reflect this variability in that they allow for three possible methods of reading.

They are:

- i) Liquid crystal diode (LCD) display, which is read manually, gives the volume passed by the meter in litres.
- ii) Pulse output, which can be counted on an electronic totaliser.
- iii) Current (mA) output, which can be evaluated electronically.

The choice of method or methods used for the calibration was left to the discretion of the laboratories. However, it was the intention of NEL, being the base laboratory, to calibrate the meters using all three outputs on each meter.

4 COMMISSIONING OF TRANSFER STANDARD

Commissioning trials were carried out during November and December 1997 and the results of these trials can be found in Reference 2.

It was decided from these trials that the current output would not be used in the intercomparison exercise as it lacked resolution.

It was noted during commissioning that the pulses generated by the meter and the LCD display reading continued changing after the flow was stopped. This was due to time required by the microprocessor to update its output. The effect was especially noticeable using the 3 mm meter and was countered by applying extended gating to standing-start-and-finish test methods. As the intercomparison was intended to compare laboratory test procedures as well as accuracy, participants were not informed of this finding. Accuracy could be maintained by comparing LCD output, where operator delay in reading the meter would compensate for the output delay.

5 ORGANISATION OF THE INTERCOMPARISON

The tables and figure in Appendices I and II show the limitations placed on the flowrate ranges used for the intercomparison. These limitations are based on the manufacturer's specified flowrate ranges and the uncertainties quoted for the flowmeters.

Three main criteria were applied:

- 1) The flowrate ranges of the two meters should overlap each other.
- 2) Extremely high flowrates should be avoided, to minimise the possibility of cavitation occurring during calibrations.
- 3) Extremely low flowrates should be excluded, to obtain the best repeatability and measurement performance from the meters.

Each meter had five flowrates nominated for the calibration and each flowrate was to be repeated five times without changing the conditions in the flow rig. One of the five flowrates, excluding the lowest flowrate in the meter range, was nominated as the control flowrate to observe the stability of the meter. This control flowrate was measured 5 times at the beginning and then again at the end of the calibration.

The instructions supplied to the participating laboratories, for setting up and using the transfer standard are reproduced in Appendix II. The laboratories were supplied with a floppy disc containing a table for the calibration results in a standard format to enable data analyses to be carried out more easily.

5.1 Schedule of Calibration

The flowmeter transfer standard was calibrated by the participating laboratories in the sequence shown in the following Table.

Laboratory
NEL, UK (initial)
WRc, UK
DTI, Denmark
SP, Sweden
NEL, UK (final)

6 RESULTS OF INTERCOMPARISON CALIBRATIONS

The complete set of data and graphical figures for all the intercomparison calibrations and all the analyses carried out on these data are included in the CD⁽³⁾. Only the graphs pertinent to the conclusions are included in this report.

For the convenience of the user, the indexes of the Tables and Figures in the CD-ROM are reproduced in Appendix IV.

6.1 Measuring Principles and Methods Used

A variety of different calibration methods and measuring principles were used by the participating laboratories as shown by the following Table.

Laboratory	Measuring Principle	Test Method	Reading Method
NEL1, UK. Heat meter rig	Gravimetric	Standing-start-and-finish	LCD reading Pulse counting
		Flying-start-and-finish	Pulse counting
NEL2, UK. Very low flow test rig	Gravimetric	Standing-start-and-finish	LCD reading Pulse counting
DTI, Denmark	Gravimetric	Standing-start-and-finish	Pulse counting
SP, Sweden	Meter prover Master meter	Flying-start-and-finish	Pulse counting
		Flying-start-and-finish	
WRc, UK	Gravimetric	Standing-start-and-finish	LCD reading

6.2 NEL1 (Initial) Calibrations

NEL1 is a small gravimetric flow rig, known as the Heat Meter Rig, having a flowrate range from 7 to 3120 l/h.

The transfer standard flowmeters were calibrated at NEL before (NEL initial) and after (NEL final) all the other participating laboratories had calibrated the meters.

6.2.1 NEL1 (initial), standing-start-and-finish

In this case, simultaneous measurements were taken from the LCD and from the pulse output during the calibrations.

During these calibrations, stopping of the pulse counter was not synchronised with closing of the diverter valve. When the flow stopped, counting continued until the last pulse had been recorded. This delay in stopping the pulse counter allows any pulses still being processed within the electronic circuits of the flowmeter to be counted after the flow has stopped (diverter valve closed). This technique is designated as extended gating in the tables of results.

6.2.2 NEL1 (initial), flying-start-and-finish

In this case, only the pulse output was measured and extended gating was not used. The pulse counter was stopped directly by a pulse initiated by the diverter valve movement at the end of the diversion (normal gating).

6.3 NEL2 Calibrations

NEL 2 is a gravimetric rig used for very small flowrates for 0.2 to 300 l/h.

Calibrations of the transfer standard were carried out on this flow facility during the intercomparison exercise. Because the flowrate sequences were not strictly followed and mean results at the selected flowrates were not available, the results of the calibrations have not been included in the main intercomparison and are given instead in Appendix III.

6.4 WRc Calibrations

The WRc facility uses the gravimetric principle of measurement, and the standing-start-and-finish method together with the LCD display was used to calculate the errors of the meters.

No calibrations were carried out using the pulsed output.

6.5 DTI, Denmark Calibrations

The Danish facility uses the gravimetric principle of measurement. The pulse output signal was used both with the standing-start-and-finish and with the flying-start-and-finish calibration methods.

6.6 SP, Sweden Calibrations

The Swedish facility uses a meter prover and a reference meter.

The flying-start-and-finish technique was used for calibrating both the 1.5 and the 3 mm meters and the pulse output signal was used in both cases.

6.7 NEL1 (Final) Calibrations

The NEL1 (final) calibrations were carried out under similar conditions to the NEL1 (initial) calibrations, as described in Section 6.1.

6.7.1 NEL1 (final) standing-start-and-finish

For each meter, simultaneous measurements were taken from the LCD and from the pulse output. Extended gating was used.

6.7.2 NEL1 (final), flying-start-and-finish

Normal gating was used in the calibration of both meters.

7 ANALYSIS OF THE DATA

The data was analysed in the following way:

- a) For calibrations using LCD displays, the results are calculated as percentage error as follows:

$$e = 100 \times (V_i - V_a) / V_a$$

where e is the error in the actual volume passed by the meter error,

V_i is the Indicated volume on the LCD display, and
 V_a is the actual volume passed by the meter, measured by the rig.

- b) For calibrations of pulse outputs the results are calculated in the following way:

$$K = P_t/V_a \quad \text{pulses/litre}$$

where K is the K-factor of the meter,
 P_t is the pulse total counted during a measurement, and
 V_a is the actual volume passed by the meter, measured by the rig.

- c) For each Laboratory, the results of the results of the five repeated measurements at each flowrate were averaged to obtain the arithmetic mean. For LCD calibrations, this gave an average error, and for pulse calibrations, this gave an average K-factor.
- d) The sample standard deviation (σ_s) of the results from each group of five repeats were calculated and then the 95% confidence limits were calculated using an expansion factor (Student's t) of 2.776.
- e) The averaged results from all the calibrations on each meter were compared as a whole and also by test method.
- f) A fixed ratio of 1000 pulses per litre was selected for the meters and this was shown to replicate the LCD display reading

The WRc calibrations, which used only the LCD displays, can only be compared directly with the equivalent NEL1 calibrations. If the above premise is accepted the volume reading from WRc can be related to an equivalent pulse output and the WRc results can be included in the comparison of all calibrations. This was done.

8 DISCUSSION OF RESULTS

All the results discussed in Sections 8.1 to 8.3 below use the mean values of the five test points at each flow. The spread and standard deviation of the results at each flow are discussed in Section 8.4.

8.1 Results from WRc and NEL, LCD Output

WRc were the only laboratory not equipped to calibrate the pulsed output of the meters and hence calibrated the meters using only the LCD display. NEL also calibrated using the LCD in addition to the pulsed output. For the standing-start-and-finish test this was carried out simultaneously. The two NEL calibrations and the WRc calibration, using the LCD display, are compared below for each meter.

The calibration data obtained using the 1.5 mm flowmeter's LCD, volume display are compared in Fig. 22.

Fig 22 Mean errors for 1.5 mm flowmeter for all data, using volume indications from LCD

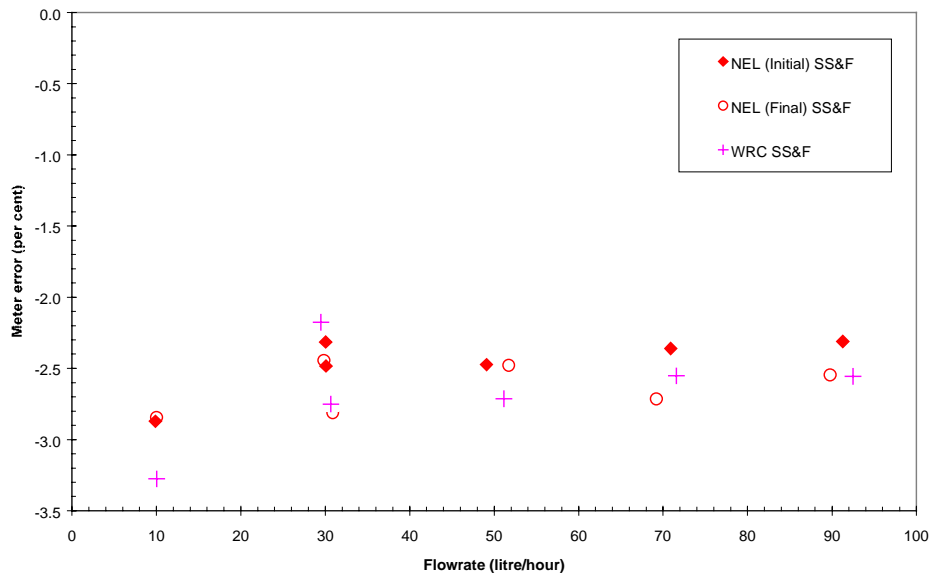

Clearly no significant difference is found between the NEL and WRC calibrations. Both lie within a spread of 0.5 per cent.

The 3 mm meter results are compared in Fig. 24.

Fig 24 Mean errors of 3 mm flowmeter for all data using volume indications from LCD

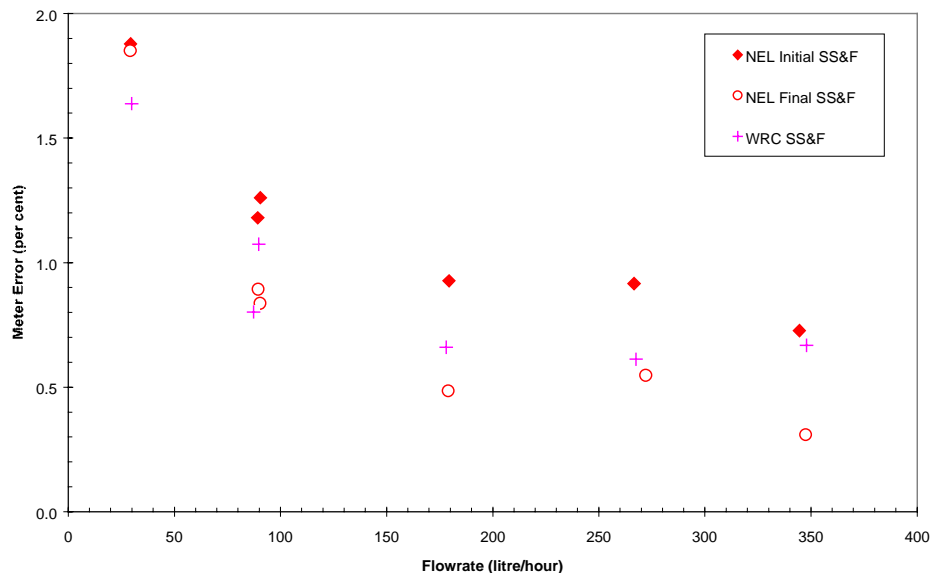

It is noted that the 3 mm meter is not as linear as the 1.5 mm meter. However, all three calibrations follow the same calibration curve and there is no significant difference between WRC and NEL, within a spread of 0.6 per cent.

Although not shown here the NEL pulsed output calibrations and the LCD display calibrations agreed very closely. From these conclusions, it was considered acceptable to include the WRC results in the main intercomparison by converting the measured volume to pulses, using the programmed relationship. This is 1000 p/l for both meters. By definition

this is the equivalent of standing-start-and-finish method with extended gating due to the delay introduced by the operator reading the meter after the flow has stopped.

8.2 Comparison of 1.5 mm Meter Pulse Calibrations

8.2.1 Comparison of NEL results

NEL calibrated the meter using both standing- and flying-start-and-finish methods both before the package left and on its return to NEL. This is to gauge the stability of the package. The four NEL calibrations for the 1.5 mm meter are compared in Fig. 29.

Fig 29 NEL1 (initial) and NEL1 (final) calibration of 1.5 mm flowmeter, using pulse output, standing-start-and-finish and flying-start-and-finish

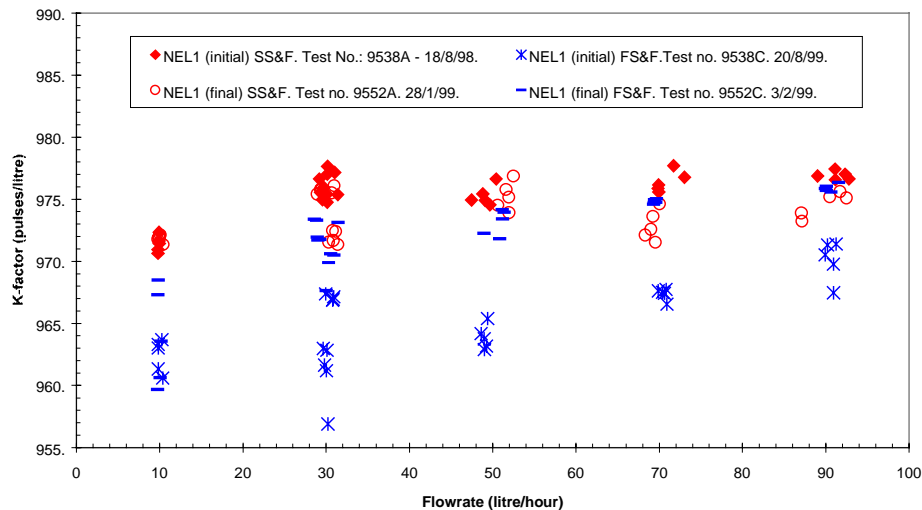

The standing-start-and-finish method results indicate that the package appeared to have a stability over the project time within 0.3 per cent.

This is confirmed by the flying-start-and-finish results for the final test.

However, the initial flying-start-and-finish calibration produced a K-factor some 1 per cent lower than the other three tests (a range of 1.5 per cent between initial standing-start-test and the initial flying-start test.). This, in isolation from results from the other laboratories, was at first considered to be a difference in method, then on receiving the final flying-start-and-finish result was considered as potentially anomalous, but no reason could be attributed.

8.2.2 Comparison of standing-start-and-finish method results

The standing-start-and-finish calibrations are shown in Fig 21a and, as stated in 8.1, the NEL and WRC results agree closely. However, the calibration curve from DTI appears to be some 0.5 to 1 per cent below those of WRC and NEL. It actually matches closely with the apparently anomalous flying-start-and-finish result from NEL and differs from the DTI flying-start-and-finish result.

Fig 21a Mean K-factor of 1.5 mm flowmeter for all data using pulse output and standing-start-and-finish.

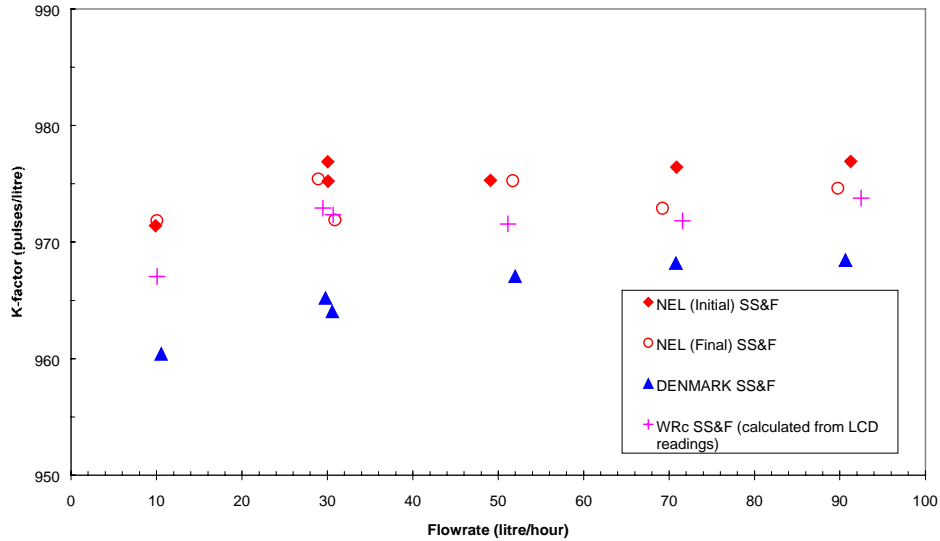

8.2.3 Comparison of flying-start-and-finish results

In this case the calibrations show, as before, the two NEL flying-start-and-finish results separated by around 1 per cent with the result from SP and DTI falling between them (see Fig 21b). From this set of results agreement within 0.1 per cent can be concluded.

Fig 21b Mean K-factor of 1.5 mm flowmeter for all data using pulse output and flying-start-and-finish.

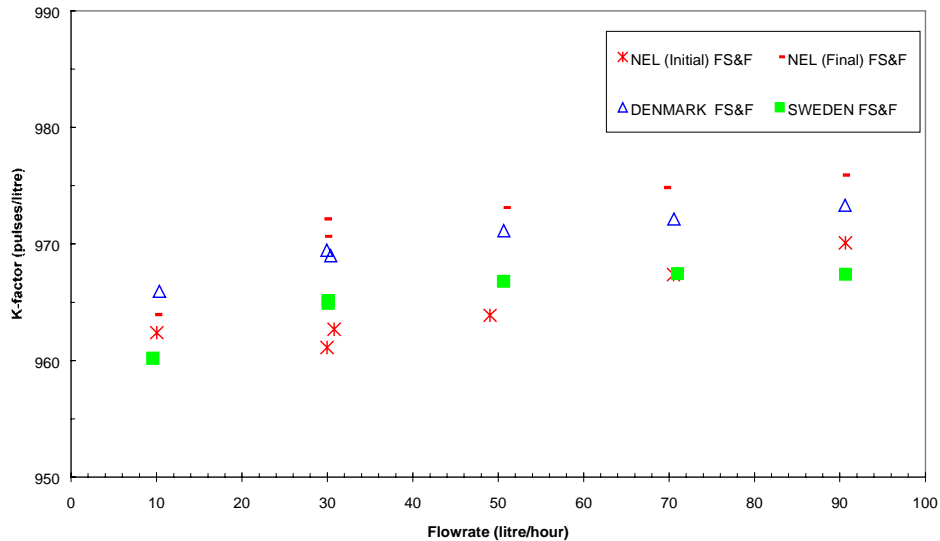

8.2.4 Overall comparison

The combined results for all the pulse output calibrations for the 1.5 mm meter are shown in Fig 21.

Fig 21 Mean K-factor of 1.5 mm flowmeter for all data using pulse output. Flying-start-and-finish/Standing-start-and-finish.

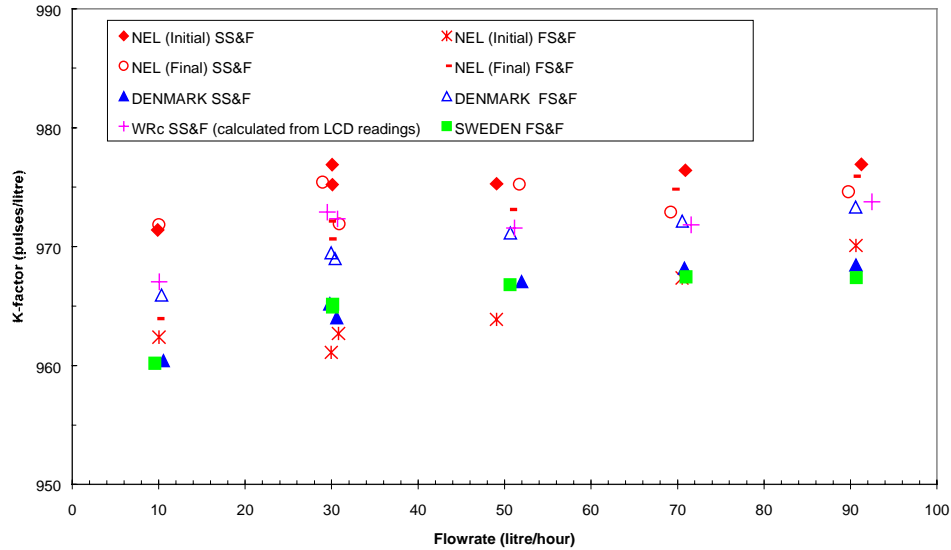

From these results it is seen that all the calibrations results lie in a range of some 1.5 per cent and bounded by the NEL initial standing and flying-start-and-finish results.

The flying-start-and-finish tests from NEL (initial) and from SP give a similar result to the DTI standing start-and-finish result. Also, the DTI flying-start results are similar to the NEL and WRc standing-start results.

From this conclusion the NEL initial flying start result cannot be considered anomalous nor can any difference in the calibrations can be attributed per se to the calibration method.

It must be concluded that the laboratories agree to within a range of 1.5 per cent and no clear difference can be attributed to the methods used.

8.3 Comparison of the 3 mm Meter Pulse Calibrations

8.3.1 Comparison of NEL results

The four NEL results are compared in Fig 30.

Fig 30 NEL (initial) and NEL (final) calibration of 3 mm flowmeter, using pulse output, standing-start-and-finish and flying-start-and-finish

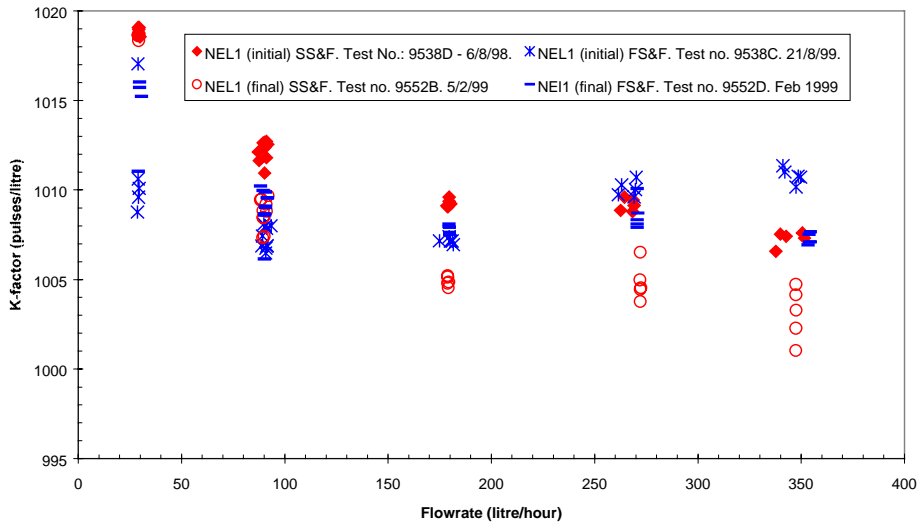

The initial and final standing-start-and-finish calibrations agree to within 0.5 per cent but agreement is considerably better at the lowest flowrate. The initial test result is higher than for the final test.

Generally, the flying-start-and-finish tests followed the same pattern, agreeing within themselves and with the standing-start-and-finish tests, to around 0.5 per cent.

8.3.2 Comparison of standing-start-and-finish results

The standing-start-and-finish results from NEL, WRC and DTI, are shown in Fig. 23a. Fig.23a shows agreement between NEL and WRC of around 0.5 per cent with the DTI results between 0.2 and 0.7 per cent lower. Overall, the four calibrations agree within 0.7 per cent.

Fig 23a Mean K-factor of 3 mm flowmeter for all data using pulse output and standing-start-and-finish.

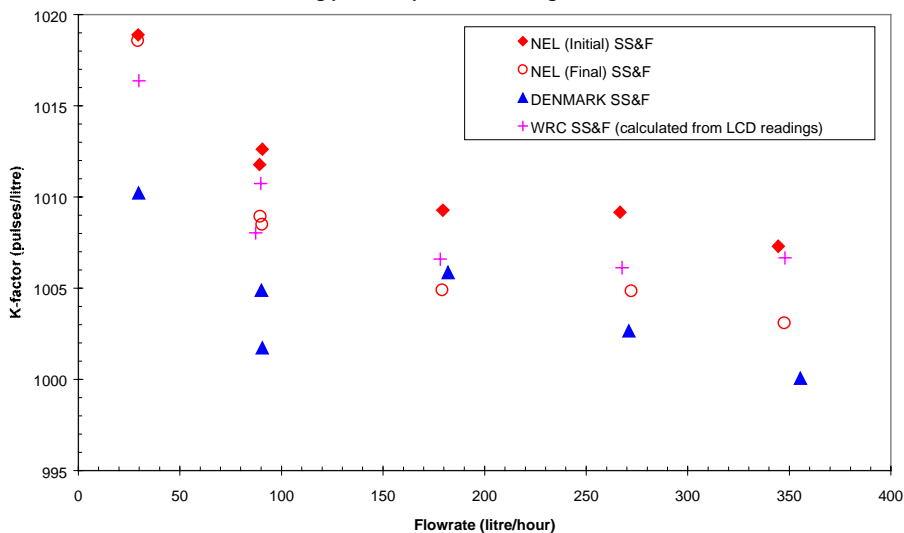

8.3.3 Comparison of flying-start-and-finish results

The flying-start-and-finish results from NEL, SP and DTI, see Fig. 23b, shows the SP results lying a little lower than NEL, with the DTI results falling in the middle. The overall spread of the results is around 0.7 per cent.

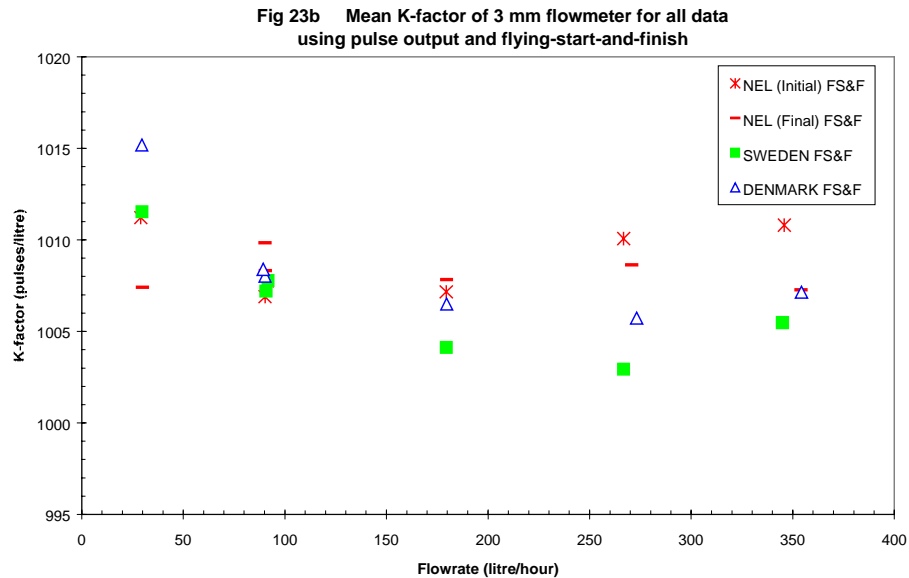

8.3.4 Overall comparison

The combined results for pulse outputs for the 3 mm meter are shown in Fig 23.

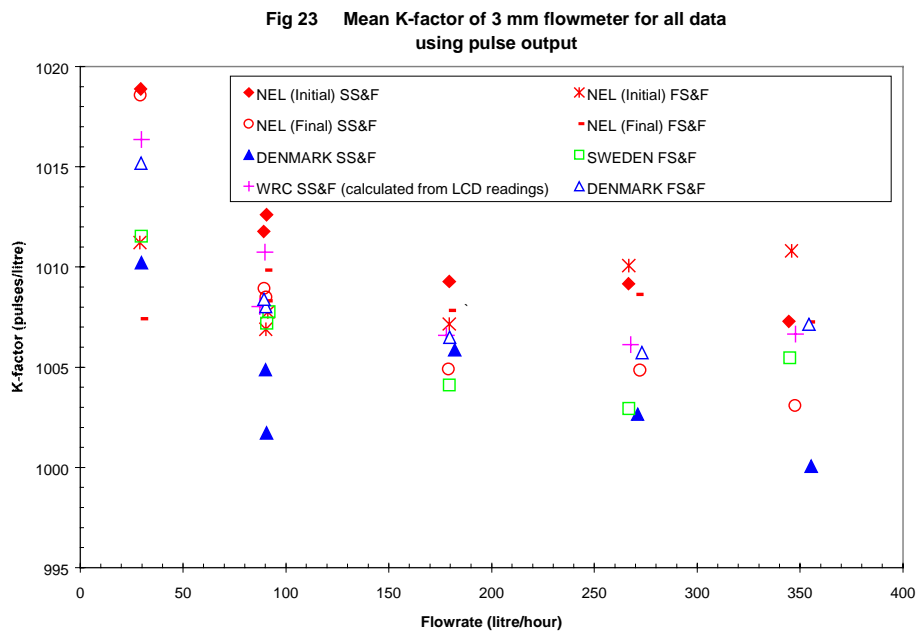

Again, it is not possible to separate differences in the calibrations, which can be attributed to either the laboratories or the test method employed. The spread of results lies in a range of 0.7 per cent.

8.4 Repeatability of Results

The above comparisons have taken place using the mean values of five points. The repeatability of the tests provides a level of confidence in these means. As the analyses can be overly complex, the table below shows the mean repeatability from each laboratory and test. The repeatability of each set of five points at a constant flowrate was calculated and the overall mean value is quoted.

**Mean repeatability across the flow range with 95 % confidence interval
[sample standard deviation (σ_s) x Student's T (t.)]**

Flowmeter (output used)	Method	NEL1 Initial %	NEL1 Final %	NEL2 %	WRc %	DTI %	SP %
1.5 mm (LCD)	SSF	0.17	0.21	--	0.72	--	--
1.5 mm (pulse)	SSF	0.17	0.21	0.19	--	0.28	--
1.5 mm (pulse)	FSF	0.37	0.42	--	--	0.06	0.13
3mm (LCD)	SSF	0.09	0.31	--	0.41	--	--
3 mm (Pulse)	SSF	0.08	0.21	--	--	0.43	--
3mm (Pulse)	FSF	0.24	0.2	--	--	0.13	0.46

The figures from the above it must be assumed that the package is capable of showing repeatability of around 0.2 per cent. This assumption puts a level of confidence, along with the uncertainty estimates of the laboratories, on the level of agreement found between laboratory tests.

8.5 Ancillary Measurements

As part of the calibration plan, the laboratories were asked to measure the conductivity of the water in the calibration rig at the start and finish of each calibration. There was also a requirement to measure the mains power supply voltage. The following Table gives the results of these measurements.

No significant differences in calibration can be attributed to the conductivity or the power voltage.

Laboratory/ Calibration	Calibration details	Water conductivity $\mu\text{S}/\text{cm}$		Mains Supply to Flowmeters volts
		before	after	
NEL, HMR (initial)	1.5 mm/SSF/LCD/pulse	392	374	245
NEL, HMR (initial)	1.5 mm/FSF/pulse	388	377	245
NEL, HMR (initial)	3 mm/SSF/LCD/pulse	390	392	245
NEL, HMR (initial)	3 mm/FSF/pulse	377	390	245
NEL, VLFR	1.5 mm/SSF/LCD	75.4	-	245

Laboratory/ Calibration	Calibration details	Water conductivity $\mu\text{S/cm}$		Mains Supply to Flowmeters
NEL, VLFR	1.5 mm/SSF/LCD	75.4	-	-
WRc	1.5 mm/SSF/LCD	134	134	239
WRc	3 mm/SSF/LCD	134	134	239
DTI, Denmark	1.5 mm/SSF/pulse	150	150	-
DTI, Denmark	1.5 mm/FSF/pulse	180	190	-
DTI, Denmark	3 mm/SSF/pulse	170	170	-
DTI, Denmark	3 mm/FSF/pulse	160	170	-
SP, Sweden	1.5 mm/FSF/pulse	-	50	230
SP, Sweden	3 mm/FSF/pulse	-	50	230
NEL, HMR (final)	1.5 mm/SSF/LCD/pulse	154	163	-
NEL, HMR (final)	1.5 mm/FSF/pulse	155	158	-
NEL, HMR (final)	3 mm/SSF/LCD/pulse	163	151	-
NEL, HMR (final)	3 mm/FSF/pulse	158	165	-

Abbreviations:
HMR – Heat meter rig
VLFR – Very low flow rig

8.6 Uncertainties of the Calibration Facilities

The calibration facilities at each laboratory are accredited with the following, standard uncertainty estimates. All are expressed with coverage factor $k=2$:

Laboratory name	Calibration rig name	Uncertainty % on volume passed	Flowrate range l/h
NEL, UK	Heat meter rig:	0.12	10 to 3120
	Very low flow rig:	0.10	0.2 to 300
DTI, Denmark	Small heat meter and flowmeter test rig:	0.05	5 to 3000
SP, Sweden	Piston prover:	0.10	6 to 6000
	Master meter:	0.15	270 and 350
WRc, UK			
	Water meter calibration rig:	0.20	7 to 7000

8.7 Relationship to Other Intercomparisons

In 1993/1994, an intercomparison exercise for hot water meters, involving 12 laboratories, was sponsored by the EU^(4,5). Calibrations were carried out at 20°C as well as at higher temperatures. Three different sizes of meter package were used and the flowrate range of the smallest package was 150 to 1500 l/h. The present intercomparison covers a flowrate range of 10 to 350 l/h. In the 1993/94 project, the calibrations at 20 °C for the two lowest flows, 150 and 300 l/h, were rejected from the analyses because of the instability of the meters and the wide scatter of results. This scatter was up to 5.75 per cent whereas, above 300 l/hr agreement within 0.13 to 0.54 per cent was achieved.

9 CONCLUSIONS

A low flow transfer standard has been designed and commissioned at the NEL, Flow Centre and subsequently used in an international intercomparison of flowmeter calibration facilities. This package covered the flow range 10 to 350 l/hr using two electromagnetic flow meters.

During the commissioning tests and subsequently in the intercomparison the package was shown to have a short-term repeatability of around 0.2 per cent. This was confirmed by results from the intercomparison.

Overall, the agreement between the laboratories and the different calibration methods lay within a range 1.5 per cent over the flow range 10 to 100 l/hr, using the 1.5 mm, transfer meter.

Over the range 30 to 350 l/hr, agreement was within 0.7 per cent using the 3 mm transfer meter.

This is a disappointing level of agreement for facilities with accredited uncertainties of around 0.1 per cent and a package with a short term repeatability of 0.2 per cent.

At this time, the relationship between water conductivity and meter performance has not been evaluated or taken into account in the intercomparison. The water conductivity values for the participating laboratories has been examined and, at first examination, does not show a correlation with meter performance. Similarly with power supply voltage, although any changes related to this effect would be considered to be minimal.

Comparison of the data from the NEL Heat Meter Rig and the NEL, Very Low Flow Rig, shows agreement within a bandwidth of 0.02 to 0.4 percent of volume passed, over the flowrate range 10 to 300 l/h.

It is unclear if the reproducibilities of the meters in the package have contributed to the differences. The commissioning tests initially indicated the meters had acceptable reproducibility within NEL before the start of the intercomparison.

Reproducibility at NEL across the intercomparison was in the order of 0.5 per cent, although including the initial 1.5 mm meter flying-start-and-finish method widens this to 1.5 per cent.

The project leaves the intercomparison and confidence in low flowrate, water calibrations within Europe considerably better than before. With agreement between 0.7 and 1.5 per cent compared with a previous project which showed 5.7 percent. However, this still cannot be considered to be a satisfactory situation as the participating laboratories have uncertainties in the order of 0.2 to 0.1 per cent, and the package has a repeatability of 0.2 per cent. Further work on developing a more stable transfer standard should be carried out and the exercise repeated in the future.

ACKNOWLEDGEMENTS

The author thanks the participating laboratories for their co-operation during the project, in particular, Mr M Thrane, DTI, Denmark, Mrs K Mattiasson, SP, Sweden and Mr S Warburton, WRc, Oakdale, UK. Thanks are also due to Mr Ian Nicholson, Mr Iain Dickson Mr C Duffell and Mr John Hay at NEL, who were involved in the design, commissioning and calibration of the transfer standard.

REFERENCES

- 1 COPA-XM electromagnetic flowmeter, with pulsed DC technology and integrally mounted converter (compact design). Bailey-Fischer & Porter technical specification, Ref. No Spec. 1.2-04/01.96, Part No D184S009U02.
- 2 DICKSON, I., and DUFFELL, C. Low flow transfer standard commissioning calibrations. Project No WSDC40500, NEL Report No 00799. East Kilbride, Glasgow: National Engineering Laboratory, 8 September 1998.
- 3 Intercomparison Work for 1996-99, DTI Flow Programme. NEL Report No 305/99 (CD-ROM). East Kilbride, Glasgow: National Engineering Laboratory, 25 August 1999.
- 4 THRANE, M., FREDERIKSEN, J., and SPENCER, E. A. Report on intercomparison of flowmeter calibration facilities for the flow of water at various temperatures. Danish Technological Institute, Aarhus, Denmark. April 1994.
- 5 FREDERIKSEN J. O., SPENCER E. A., and THRANE M. I. Intercomparison of flowmeter calibration facilities for the measurement of the flow of water at various temperatures. FLOMEKO '94. Flow measurement in the mid-90's. 7th International Conference on Flow Measurement, 13 – 17 June 1994 in Glasgow, Scotland.

APPENDIX I

**FLOWRATE RANGES OF BAILEY-FISCHER & PORTER,
1, 1.5, 2 and 3 mm BORE, COPA XM FLOWMETERS**

Specified uncertainty of flowmeters is, 0.2 percent of flowrate, or 0.002 m/s, whichever is greater. Velocity range for an uncertainty of 0.2 percent of flowrate = 1 to 15 m/s.

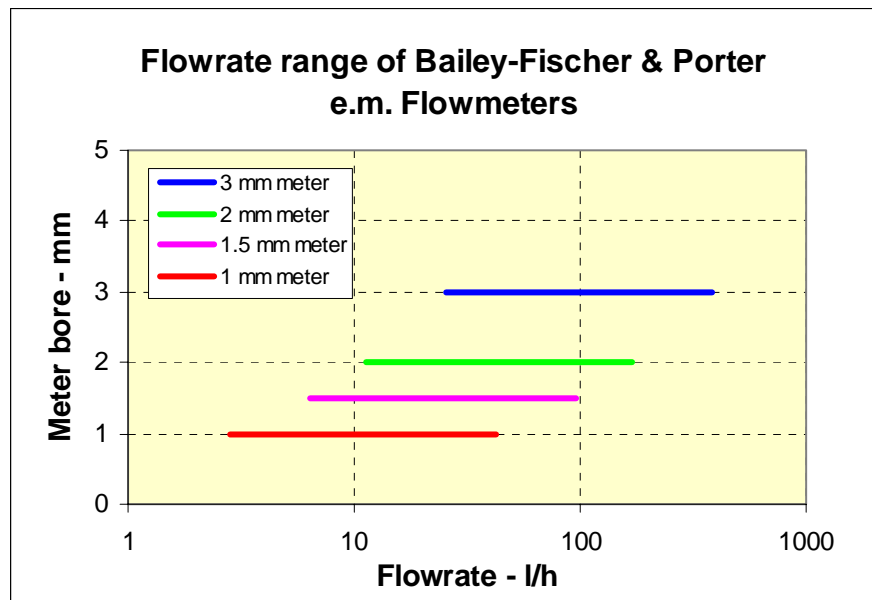

APPENDIX II

ASSEMBLY AND CALIBRATION GUIDANCE NOTES FOR TRANSFER STANDARD

LOW FLOW INTERCOMPARISON PROJECT - REF. WSDC40 - DESCRIPTION OF PROJECT AND PROCEDURES

II.1 OBJECTIVES OF THE INTERCOMPARISON

- a) To have a flowmeter transfer package calibrated at several laboratories on the laboratories own water flow calibration rigs and using the laboratories own calibration methods and staff.
- b) To analyse the data for differences between the calibrations from the various laboratories.
- c) To try to identify the causes, where the calibration results are statistically different.
- d) To report the findings.

II.2 DETAILS OF ELECTROMAGNETIC FLOWMETERS

II.2.1 Small Flowmeter

Manufacturer:	Bailey-Fischer & Porter
Bore diameter:	1.5 mm
Model:	COPA-XM, 10DX2312, DN 1.5, PN10
Flowmeter Serial Nos:	9705L1290 / A1
Converter Serial Nos:	9705L1290 / B1
Flowrate range used:	10 to 90 litres per hour (velocity 1.5 to 14 m/s)
Maximum flowrate in converter is set to:	108 l/h
Meter uncertainty quoted:	0.2 per cent of flowrate
Fluid temperature range:	-25 to 130°C
Ambient temperature range:	-25 to 60°C
Maximum working pressure:	10 bar

II.2.2 Large Flowmeter

Manufacturer:	Bailey-Fischer & Porter
Sizes:	3.0 mm
Model:	COPA-XM, 10DX2312, DN 3, PN10
Flowmeter Serial Nos:	9706L1188 / A1
Converter Serial Nos:	9706L1188 / B1
Flowrate range used:	30 to 350 litres per hour (velocity 1 to 14 m/s)
Maximum flowrate in converter is set to:	310 l/h
Meter uncertainty quoted:	0.2 per cent of flowrate
Fluid temperature range:	-25 to 130°C
Ambient temperature range:	-25 to 60°C
Maximum working pressure:	10 bar

II.3 FLOWMETER CALIBRATIONS

The intercomparison exercise is intended to evaluate each calibration rig as it would normally be used. Therefore, the laboratories should see that the procedures which they would normally apply to flowmeter calibrations are followed. If for any reason they have to depart from normal procedures in any respect, then the procedural changes and the reasons for them should be noted and included in the report.

The following tables describe the flowrates and sequence of the calibration for both flowmeters in the transfer standard. The Annex below describes the installation and calibration procedure.

The calibrations are carried out using water as the medium in the rig.

The calibration must be carried out within the tolerances and in the sequence shown. Five consecutive measurements must be made at each flowrate before moving to the next flowrate. If possible, complete the calibration of each flowmeter in the same day.

II.3.1 Flowmeter No 1: 1.5 mm Bore

1.5 mm, COPA-XM, 10DX2312, Flowmeter			
Flowrate Ref No	Nominal Flowrate Q l/h	Flowrate tolerances (Q ± 5 %)	
		l/h	
		Minimum	Maximum
2	30	28.5	31.5
1	10	9.5	10.5
5	90	85.5	94.5
3	70	66.5	73.5
4	50	47.5	52.5
2	30	28.5	31.5

II.3.2 Flowmeter No 2: 3 mm Bore

3 mm, COPA-XM, 10DX2312, Flowmeter:			
Flowrate Ref No	Nominal Flowrate Q l/h	Flowrate tolerances (Q ± 5 %)	
		l/h	
		Minimum	Maximum
2	90	85.5	94.5
1	30	28.5	31.5
5	350	332.5	367.5
4	270	256.5	283.5
3	180	171.0	189.0
2	90	85.5	94.5

Follow the installation and calibration procedure given in the Annex below.

ANNEX

**INSTALLATION AND CALIBRATION PROCEDURE FOR 1.5 mm and 3.0 mm,
E.M. FLOWMETER ASSEMBLY**

1 On receiving the transfer standard, (two boxes), remove the meter assembly and the electronic units from their boxes and check them to see if any damage is apparent.

If any damage can be seen, please contact NEL on:

Tel + 44 (0) 1355 272XXX
Fax + 44 (0) 1355 272536

Jim Williamson 089 (jwilliamsn@nel.uk)
Iain Dickson 540 (idickson@nel.uk)
Richard Paton 965 (rpaton@nel.uk)

2 Please handle the assemblies with care **and do not alter any of the converter settings** as this may invalidate previous and subsequent calibrations of the meters.

3 The meter assembly, Sketch A.1, should be fitted into the water flow calibration rig and connected to the rig pipework by suitable inlet and outlet pipes, with flowrate direction as indicated on the assembly. The assembly should be well supported on its baseplate. Loading across the inlet and outlet connections should be avoided.

4 Locate the converter assembly in a suitable place near the meter assembly and connect the signal cable on each meter to the correct converter. The serial numbers on the units can be used as a guide. The cable connectors are designed to locate only in the correct sockets.

5 Air should be removed from the assembly by passing water through the 3 mm meter then through the 1.5 mm meter for a total time of at least 30 minutes using the ball valves to direct the flow, then stop the flow by closing the valves.

6 The meters are calibrated one at a time and there is no preference for which order they are calibrated. Ensure that the ball valves for the meter under test are fully open and that the valves for the second meter are properly closed.

7 If required, the pulse signal from the converter, should be connected to the rig data logger or measuring instruments, via the twin jack plug and/or 5 volt T.T.L. as appropriate. (see Sketch A.2).

8 Power up the unit using the mains supply.

9 If the LCD volume indication is to be used in the calibration, ensure that the display does not pass through zero during a calibration. When required, the LCD volume indication can be reset to zero by pressing the 'VOLUME RESET' button on the front panel.

10 Carry out a pre-calibration at flow rate no. 1 for both meters (see Section 3 of this report) repeating each measurement three times. Fax results to NEL.

NEL will verify whether the calibrations should continue.

11 If the calibrations are to continue, calibrate the meters at the flowrates shown in Section 3, with each flowrate repeated five times consecutively.

12 If possible use more than one method of calibration. e.g. the meters may be calibrated using the flying-start-and-finish and then by the standing start-and-finish. This will maximise the information obtained from the intercomparison.

13 Process the data in the normal way and tabulate the results in a table/s similar to that supplied on floppy disc.

14 Ensure that both the un-processed data and the processed data are kept in case of need but do not send this to NEL at this time.

15 Produce a report on the calibrations with the data tabulated as described in 13 above. Include all observations relevant to the calibration including any problems encountered. Include an annotated schematic diagram of the calibration rig with important components and measuring principle identified.

Details of the water conductivity may be useful.

16 If possible, also supply the data to NEL on computer disc in an Microsoft Excel spreadsheet.

17 Repack the assemblies in their boxes and send to the next laboratory. NEL will confirm their destination.

18 If any delays are anticipated please report these to the Project Manager at NEL.

Prepared by J Williamson
5 June 1998

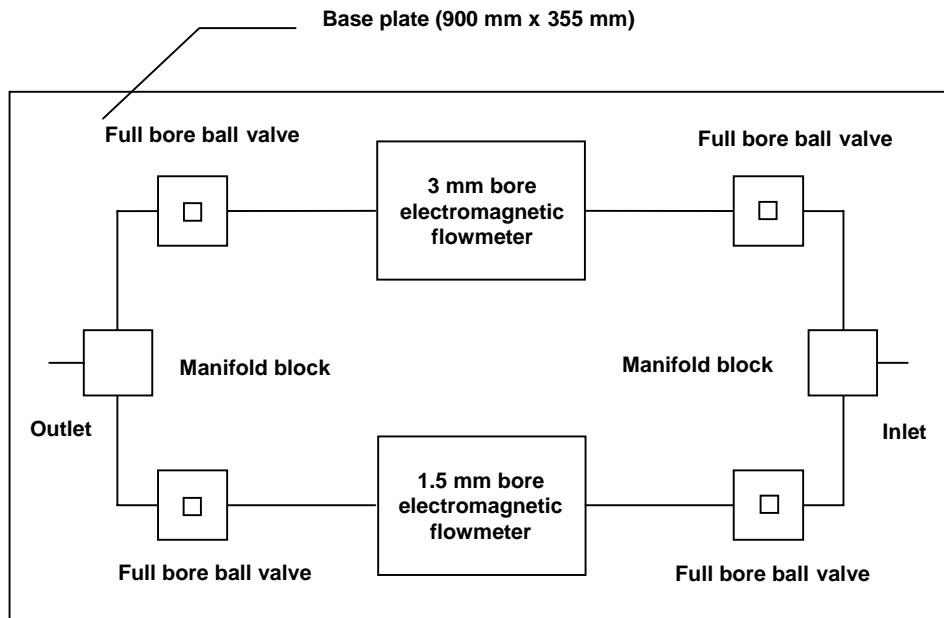

Inlet and outlet connections are 1/4 BSP (parallel) internal thread

PLAN VIEW

Sketch A1 - 21/1/98

Low Flow Transfer Standard
General layout of flowmeter package

J Williamson
NEL Flow Centre

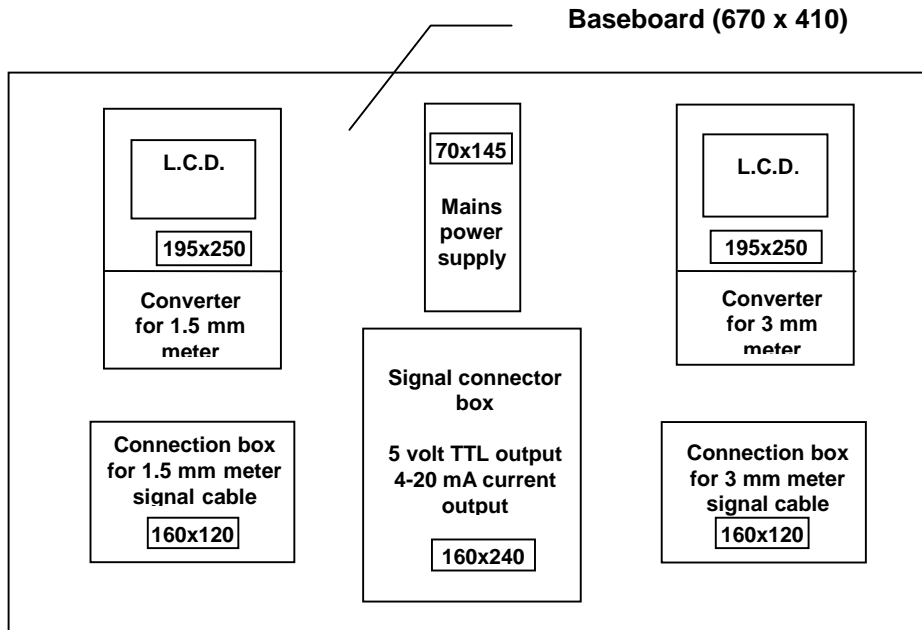

PLAN VIEW

**BOX
DIMENSIONS:
LxBxD
760x490x230**

All dimensions in mm

Sketch A2- 21/1/98

Low Flow Transfer Standard
General layout of converter package
(with dimensions)
J Williamson
NEL Flow Centre

APPENDIX III

INTERCOMPARISON OF DATA FROM NEL, VERY LOW FLOW, CALIBRATION FACILITY

III.1 Results of Calibrations of NEL2 Very Low Flow Calibration Rig

The following comparisons of the results from the NEL1 and NEL2 flow calibration rigs are made. The data is shown in the graphs, Figs III.2 and III.4

All tests were carried out using the standing-start-and-finish method. In each case the very low flow facility results lie within 0.2 to 0.3 per cent of the NEL heat meter results, and lie easily within the overall intercomparison agreement of 0.7 per cent for the 3 mm meter and 1.5 per cent agreement for the 1.5 mm meter.

III.1.2 1.5 mm meter - Pulse measurements

Fig III.2 Comparison of NEL calibration of 1.5 mm flowmeter on Very Low Flow Test Rig, using pulse output and standing-start-and-finish

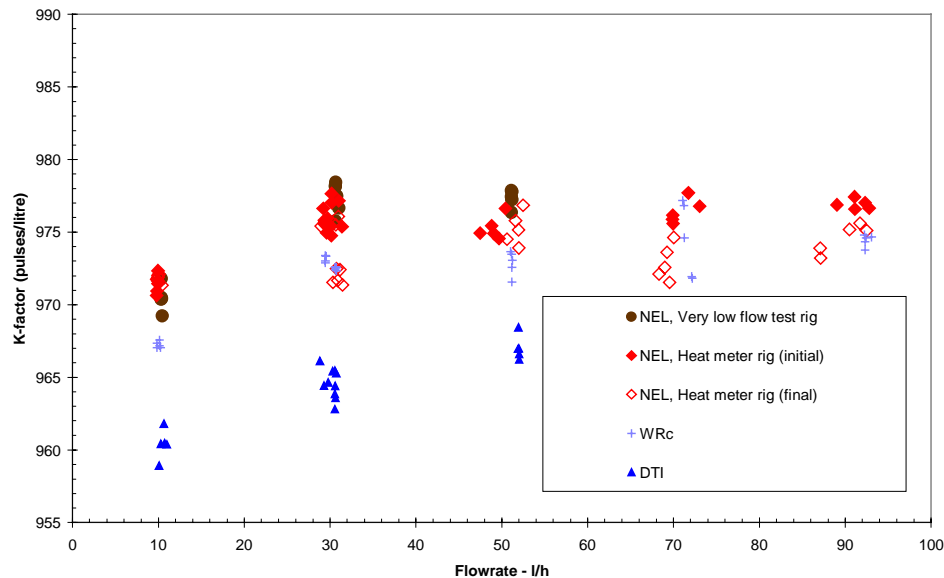

The results agree within 0.5 per cent band from the NEL1 and the WRc results. The DTI results for standing start and finish tests are significantly lower but this is discussed in the main report. They do form part of the main body of test results which show an overall range of some 1.5 per cent and should not be taken out of context in this Appendix.

III.1.2 3 mm meter - Pulse measurements

Fig III.4 Comparison of NEL calibration of 3 mm flowmeter on Very Low Flow Test Rig using pulse output and standing-start-and-finish (Data from commissioning trials)

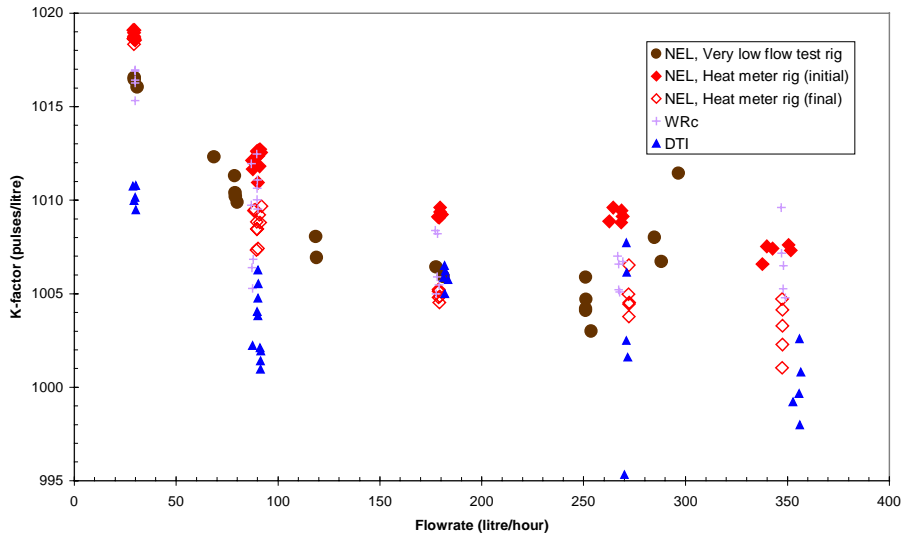

The results show agreement with the NEL1 and WRc calibrations well within 0.5 per cent. The DTI results again are somewhat lower but again fall within the overall calibration curve agreement in this case of 0.7 per cent based on the mean values.

APPENDIX IV

INDEX OF TABLES AND FIGURES IN CD-ROM, NEL REPORT No 305/99

Table No	Low Flow Transfer Standard - <i>List of Tables</i>	Ref No
1	NEL (initial) results. Calibration of the 1.5 mm flowmeter using volume indications on the LCD display (standing-start-and-finish)	NEL (initial)
2	NEL (initial) results. Calibration of the 1.5 mm flowmeter using pulse output signal with extended gating (standing-start-and-finish)	NEL (initial)
3	NEL (initial) results. Calibration of the 1.5 mm flowmeter using pulse output signal with normal gating (flying-start-and-finish)	NEL (initial)
4	NEL (initial) results. Calibration of the 3 mm flowmeter using volume indications on the LCD display (standing-start-and-finish)	NEL (initial)
5	NEL (initial) results. Calibration of the 3 mm flowmeter using pulse output signal with extended gating (standing-start-and-finish)	NEL (initial)
6	NEL (initial) results. Calibration of the 3 mm flowmeter using pulse output signal with normal gating (flying-start-and-finish)	NEL (initial)
7	WRc results. Calibration of the 1.5 mm flowmeter using volume indications on the LCD display (standing-start-and-finish)	WRc
8	WRc results. Calibration of the 3 mm flowmeter using volume indications on the LCD display (standing-start-and-finish)	WRc
9	DTI, Denmark results. Calibration of the 1.5 mm flowmeter using pulse output signal (standing-start-and-finish)	Denmark
10	DTI, Denmark results. Calibration of the 1.5 mm flowmeter using pulse output signal (flying-start-and-finish)	Denmark
11	DTI, Denmark results. Calibration of the 3 mm flowmeter using pulse output signal (standing-start-and-finish)	Denmark
12	DTI, Denmark results. Calibration of the 3 mm flowmeter using pulse output signal (flying-start-and-finish)	Denmark
13	SP, Sweden results. Calibration of the 1.5 mm flowmeter using pulse output signal (flying-start-and-finish)	Sweden
14	SP, Sweden results. Calibration of the 3 mm flowmeter using pulse output signal (flying-start-and-finish)	Sweden
15	NEL (final) results. Calibration of the 1.5 mm flowmeter using volume indications on the LCD display (standing-start-and-finish)	NEL (final)
16	NEL (final) results. Calibration of the 1.5 mm flowmeter using pulse output signal with extended gating (standing-start-and-finish)	NEL (final)
17	NEL (final) results. Calibration of the 1.5 mm flowmeter using pulse output signal with normal gating (flying-start-and-finish)	NEL (final)
18	NEL (final) results. Calibration of the 3 mm flowmeter using volume indications on the LCD display (standing-start-and-finish)	NEL (final)
19	NEL (final) results. Calibration of the 3 mm flowmeter using pulse output signal with extended gating (standing-start-and-finish)	NEL (final)
20	NEL (final) results. Calibration of the 3 mm flowmeter using pulse output signal with normal gating (flying-start-and-finish)	NEL (final)
21	Mean errors and error differences for 1.5 mm flowmeter. All data using LCD display (standing-start-and-finish)	
22	Mean K-factor and K-factor differences (%), for 1.5 mm flowmeter. All data using pulse output (standing-start-and-finish)	
23	Mean errors and error differences for 3 mm flowmeter. All data using LCD display (standing-start-and-finish)	
24	Mean K-factor and K-factor differences (%), for 3 mm flowmeter. All data using pulse output (standing-start-and-finish)	
25	Mean K-factor and K-factor differences (%), for 1.5 mm flowmeter. All data using pulse output (flying-start-and-finish)	
26	Mean K-factor and K-factor differences (%), for 3 mm flowmeter. All data using pulse output (flying-start-and-finish)	
27	Comparison of repeatability of results for 1.5 mm flowmeter, using LCD display.	
28	Comparison of repeatability of results for 1.5 mm flowmeter, using pulse output.	
III.1	Calibration of 1.5 mm flowmeter in Very Low Flow Test Rig	NEL, VLFR
III.2	Calibration of 3 mm flowmeter in Very Low Flow Test Rig	NEL, VLFR
For table nos. ref., ' III.__', see Annex III of the Excel file on the CD ROM		

Figure	Low Flow Transfer Standard - <i>List of Figures</i>	Lab
--------	-----------------------------------------------------	-----

National Engineering Laboratory

No		Ref
1	NEL (initial). Calibration of 1.5 mm flowmeter, using volume indication on LCD display (standing-start-and-finish)	NEL (initial)
2	NEL (initial). Calibration of 1.5 mm flowmeter, using pulse output (standing-start-and-finish with extended gating)	NEL (initial)
3	NEL (initial). Calibration of 1.5 mm EM meter, using pulse output (flying-start-and-finish with normal gating)	NEL (initial)
4	NEL (initial). Calibration of 3 mm flowmeter, using volume indication on LCD display (standing-start-and-finish)	NEL (initial)
5	NEL (initial). Calibration of 3 mm flowmeter, using pulse output (standing-start-and-finish with extended gating)	NEL (initial)
6	NEL (initial). Calibration of 3 mm flowmeter, using pulse output (flying-start-and-finish with normal gating)	NEL (initial)
7	WRc. Calibration of 1.5 mm flowmeter, using volume indication on LCD display (standing-start-and-finish)	WRc
8	WRc. Calibration of 3 mm flowmeter, using volume indication on LCD display (standing-start-and-finish)	WRc
9	DTI, DENMARK. Calibration of 1.5 mm flowmeter, using pulse output (standing-start-and-finish)	Denmark
10	DTI, DENMARK. Calibration of 3 mm flowmeter, using pulse output (standing-start-and-finish)	Denmark
11	DTI, DENMARK. Calibration of 1.5 mm flowmeter, using pulse output (flying-start-and-finish)	Denmark
12	DTI, DENMARK. Calibration of 3 mm flowmeter, using pulse output (flying-start-and-finish)	Denmark
13	SP, SWEDEN. Calibration of 1.5 mm flowmeter, using pulse output (flying-start-and-finish)	Sweden
14	SP, SWEDEN. Calibration of 3 mm flowmeter, using pulse output (flying-start-and-finish)	Sweden
15	NEL (final). Calibration of 1.5 mm flowmeter, using volume indication on LCD display (standing-start-and-finish)	NEL (final)
16	NEL (final). Calibration of 1.5 mm flowmeter, using pulse output (standing-start-and-finish with extended gating)	NEL (final)
17	NEL (final). Calibration of 1.5 mm flowmeter, using pulse output (flying-start-and-finish with normal gating)	NEL (final)
18	NEL (final). Calibration of 3 mm flowmeter, using volume indication on LCD display (standing-start-and-finish)	NEL (final)
19	NEL (final). Calibration of 3 mm flowmeter, using pulse output (standing-start-and-finish with extended gating)	NEL (final)
20	NEL (final). Calibration of 3 mm flowmeter, using pulse output (flying-start-and-finish with normal gating)	NEL (final)
21	Mean K-factors from 1.5 mm flowmeter for all data using pulse output SS&F and FS&F	
21a	Mean K-factors from 1.5 mm flowmeter for all data using pulse output and standing-start-and-finish	
21b	Mean K-factors from 1.5 mm flowmeter for all data using pulse output and flying-start-and-finish	
22	Mean errors for 1.5 mm flowmeter for all data using volume indications from LCD	
23	Mean K-factors from 3 mm flowmeter for all data using pulse output FS&F and SS&	
23a	Mean K-factors from 3 mm flowmeter for all data using pulse output and standing-start-and-finish	
23b	Mean K-factor of 3 mm flowmeter for all data using pulse output and flying-start-and-finish	
24	Mean errors for 3 mm flowmeter for all data using volume indications from LCD	
25	Mean LCD error differences. 1.5 mm flowmeter using, using mean errors of NEL initial and final data as baseline	
26	Mean K-factor percentage differences, for 1.5 mm flowmeter, using mean K of NEL initial & final data as baseline	
27	Mean LCD error differences. 3 mm flowmeter using, using mean errors of NEL initial and final data as baseline	
28	Mean K-factor percentage differences, for 3 mm flowmeter, using mean K of NEL initial & final data as baseline	
29	NEL1 (initial) and NEL1 (final) calibration of 1.5 mm flowmeter, using pulse output, standing-start-and-finish and flying-start-and-finish	NEL1
30	NEL (initial) and NEL (final) calibration of 3 mm flowmeter, using pulse output, standing-start-and-finish and flying-start-and-finish	NEL1

Figure No	Low Flow Transfer Standard - <i>List of Figures</i>	Lab Ref
III.1	Comparison of NEL calibration of 1.5 mm flowmeter on VLFR, using volume indication from LCD display (standing-start-and-finish)	NEL, VLFR
III.2	Comparison of NEL calibration of 1.5 mm flowmeter on Very Low Flow Test Rig using pulse output (standing-start-and-finish)	NEL, VLFR
III.3	Comparison of NEL calibration of 3 mm flowmeter on VLFR, using volume indication from LCD display (standing-start-and-finish)	NEL, VLFR
III.4	Comparison of NEL calibration of 3 mm flowmeter on Very Low Flow Test Rig using pulse output (standing-start-and-finish)	NEL, VLFR
For figure nos. ref., ' III._', see Annex III of the Excel file on the CD ROM		